

FM 3-34.468

**Seabee Quarry Blasting
Operations
and Safety Manual**

HEADQUARTERS, DEPARTMENT OF THE ARMY

DECEMBER 2003

DISTRIBUTION RESTRICTION: Approved for public release; distribution is unlimited.

**This publication is available at Army
Knowledge Online (www.us.army.mil)
and the General Dennis J. Reimer
Training and Doctrine Digital Library at
(www.adtdl.army.mil).**

US ARMY PREFACE

19 DECEMBER 2003

PURPOSE

This manual is a guide for engineer personnel responsible for planning, designing, and conducting blasting operations in pits and quarries. This manual should be used in conjunction with current Army blasting doctrine. Although this manual focuses on techniques and procedures used in Navy blasting, it mirrors standards that have been adopted by and used in the civilian blasting sector.

SCOPE AND APPLICABILITY

Engineer personnel assigned to blasting and quarry teams must have a basic understanding of blasting operations in pits and quarries to successfully operate a quarry while effectively producing crushed rock. Quarrying specialists enhance their skills primarily from experience in problem solving, overcoming obstacles in the field, and learning from failures. Using this manual, information and guidance established in current Army doctrine, and blasting guidance set forth in Field Manual (FM) 5-250, the quarrying specialist or foreman will perform more efficiently, effectively, and safely in the field. This manual mentions explosive agents that are not currently available through standard Army procurement. It is fundamentally important for a quarrying foreman to consider all resources available in the Department of Defense (DOD) and the civilian sector. It may be necessary to use nonstandard agents in a contingency environment when nothing else is available. However, until other blasting agents are approved for Army use in quarry operations, each user must request and obtain a waiver, through proper military channels, to use anything other than military-grade dynamite.

NOTE: Current Army doctrine is under revision and should be released sometime in 2004.



Naval Facilities
Engineering Command

Seabee Policy and
Doctrine Division

First Edition



Seabee Quarry Blasting Operations and Safety Manual

NAVFAC P-1095
April 1994



Seabee Memorial

Avenue of Heroes

Arlington National Cemetery

SN0575-LP-543-6800



ACKNOWLEDGMENT

Grateful acknowledgment is made to the International Society of Explosives Engineers and Explosives Technologies International for permission to reprint text and illustrations used throughout this manual, taken from the 16th Edition of the Du Pont *Blasters' Handbook*.

Special thanks to EOCS Patrick D. Flinton, USN, Ret., for preparation of the text and illustrations and Mr. Robert S. Soluri and EQCM(SCW) Gerald P. Napert, USN, for editing, cover layout and camera-ready formatting of the first edition of this manual.

FOREWORD

This manual provides Commander, Naval Facilities Engineering Command (COMNAVFACENGCOM) guidance and training of Naval Construction Force (NCF) units in the development of quarry operations; blasting techniques and procedures, and construction explosive safety.

This manual is intended to be a source document for NCF units, particularly Naval Construction Regiments and Naval Mobile Construction Battalions, to plan, develop and operate quarries, and to conduct blasting operations. Copies are available from NCTC, Port Hueneme, CA. Recommended changes are solicited. Send recommendations to NAVFACENGCOMHQ (Code 12).

Although this manual contains specific instructions for the use of "Water Gel" explosives, qualification of "Water Gel" has not been completed. At the time of this printing NSWCC Crane was in the process of qualifying "Water Gel" for Navy use and we anticipate full qualification and introduction into the Navy system during FY 94. Until "Water Gel" is approved for Navy use, each user must request and obtain a waiver for its use from NAVSEASYSYSCOM, Code 65.

This publication is certified as an official command publication and has been reviewed and approved in accordance with SECNAV Instruction 5600.16, "Review of Department of the Navy (DON) Publications; Procedures governing".



E. P. Nicholson
Captain, U.S. Navy
Chief of Staff
Naval Ordnance Center



J. L. Delker
Captain, CEC, U.S. Navy
Director, Manpower Management
and Seabee Support

CONTENTS

	PAGE
CHAPTER 1 GEOLOGY	
1.0. Analysis and Properties of Common Rock.....	1-1
1.1. Igneous Rocks.....	1-1
1.1.1. Common Igneous Rocks and Their Properties.....	1-1
1.1.2. Engineering Properties of Igneous Rocks.....	1-2
1.2. Sedimentary Rock.....	1-2
1.2.1. Common Sedimentary Rocks and Their Properties.....	1-2
1.2.2. Engineering Properties of Sedimentary Rocks.....	1-3
1.3. Metamorphic Rocks.....	1-3
1.3.1. Common Metamorphic Rocks and Their Properties.....	1-3
1.3.2. Engineering Properties of Metamorphic Rocks.....	1-3
1.4. Identification of Common Rocks.....	1-3
1.4.1. Moh's Hardness Scale.....	1-3
1.4.2. Expedient Scale.....	1-3
1.4.3. Taste Test.....	1-3
1.4.4. Color.....	1-3
1.4.5. Tenacity.....	1-3
1.4.6. Acid Test.....	1-4
CHAPTER 2 QUARRY SELECTION	
2.0. Site Selection.....	2-1
2.1. Area Reconnaissance.....	2-1
2.1.1. Preliminary Reconnaissance.....	2-1
2.1.2. Field Reconnaissance.....	2-2

CONTENTS

	PAGE
2.2. Site Evaluation.....	2-2
2.2.1. Quality.....	2-2
2.2.3. Other Evaluation Factors.....	2-2
2.2.4. Existing Sites.....	2-2
2.3. Classification.....	2-2
2.3.1. Hard Rock.....	2-2
2.3.2. Medium Rock.....	2-2
2.3.3. Soft Rock.....	2-2
 CHAPTER 3 QUARRY LAYOUT AND DEVELOPMENT	
3.0. Quarry Layout.....	3-1
3.1. Determining the Direction of the Face.....	3-1
3.2. Types of Quarries.....	3-2
3.3. Other Considerations for Quarry Layout.....	3-2
3.4. Quarry Development.....	3-3
3.4.1. Starting Work.....	3-3
3.4.2. Dual Level Crusher Operations.....	3-3
3.4.3. Rock Crusher Site Preparation.....	3-4
3.4.4. Stationing the Plant.....	3-4
3.4.5. Hopper Extensions.....	3-4
3.4.6. Loading Chute.....	3-4
3.4.7. Grizzlies.....	3-4
3.4.8. Maintenance Areas.....	3-4

CONTENTS

PAGE

3.4.9. Access Roads.....	3-4
3.4.10. Overburden Removal.....	3-5
3.5. Cut Design.....	3-5

CHAPTER 4 BLAST DESIGN

4.0. Blasting Design.....	4-1
4.1. Powder Factor.....	4-1
4.2. Powder Factor Procedures.....	4-1
4.3. Drying Boreholes.....	4-1
4.4. Bench Height.....	4-3
4.5. Toe.....	4-3
4.6. Cubic Yards and Tons.....	4-3
4.7. Log Books and Records.....	4-3
4.7.1. Drilling Records.....	4-3
4.7.2. Loading Record.....	4-4
4.7.3. Shot Record.....	4-4
4.7.4. Explosive Log.....	4-4
4.8. Drilling Patterns.....	4-4
4.8.1. Single Row Pattern.....	4-4
4.8.2. Multiple Row Patterns.....	4-4

CHAPTER 5 EXPLOSIVES AND INITIATING DEVICES

5.0. Types of Explosives and Initiating Devices That Are Used by the NCF.....	5-1
---	-----

CONTENTS

	PAGE
5.1. Explosive Types	5-1
5.1.1. M-1 Dynamite.....	5-1
5.1.2. Water Gel	5-1
5.1.3. Ammonium Nitrate (ANFO).....	5-1
5.1.4. Detonating Cord.....	5-1
5.1.5. Detaprime	5-2
5.2. Initiating Devices	5-2
5.2.1. NONEL	5-2
5.2.2. Electric Blasting Caps.....	5-2
5.2.3. Non electric Blasting Caps	5-3
5.2.4. Safety Fuse.....	5-3
5.2.5. M60 Weatherproof Fuse Igniter.....	5-3
5.2.6. MS-Connectors	5-3
5.3. Blasting Equipment and Accessories	5-4
5.3.1. Capacitor Discharge Blasting Machines	5-4
5.3.2. Push-Down Blasting Machine	5-4
5.3.3. No. 10 Twist Blasting Machine	5-5
5.3.4. DuPont SS-240	5-5
5.3.5. Rheostat	5-5
5.3.6. Blasting Galvanometer	5-5
5.3.7. Blaster's Multimeter	5-5
5.3.8. Cap Crimper	5-6

CONTENTS

	PAGE
5.3.9. Tamping Stick.....	5-6
CHAPTER 6 BLASTING	
6.0. Purpose and Scope.....	6-1
6.1. Primer Make-Up.....	6-1
6.1.1. Primer Assembly with Detonating Cord.....	6-1
6.1.2. Primer Assembly with Cap and Fuse.....	6-1
6.1.3. Primer Assembly with Electric Blasting Cap.....	6-3
6.2. Blasting With Detonating Cord.....	6-3
6.2.1. Ability to Initiate Other Explosives.....	6-3
6.2.2. Non electric Blasting Systems.....	6-3
6.2.3. Priming and Loading.....	6-3
6.2.4. Knots, Connections, and Layouts.....	6-5
6.2.5. Types of Knots, Splices.....	6-6
6.2.6. Shot Patterns.....	6-6
6.2.7. Instantaneous Firing.....	6-7
6.2.8. Surface Delay Systems.....	6-7
6.2.9. Ditching.....	6-8
6.2.10. Igniting Det Cord.....	6-8
6.3. Blasting with Non electric Cap and Safety Fuse.....	6-9
6.3.1. Lighting the Safety Fuse.....	6-9
6.3.2. Safety Reminders Using Safety Fuse and Non electric Blasting Caps.....	6-10
6.4. Electric Firing Techniques.....	6-10
6.4.1. Successful Electrical Blasting—Four General Principles.....	6-10

CONTENTS

	PAGE
6.4.2. Circuit Selection	6-10
6.4.3. Electrical Misfires	6-11
6.4.4. Safety Requirements	6-11
6.4.5. Current Requirements	6-11
6.4.6. Testing Blasting Circuits	6-11
6.4.7. Locating a Break in the Circuit	6-14
6.4.8. Capacitor Discharge Firing	6-15
6.4.9. Series Circuit	6-15
6.4.10. Determining the Electrical Circuitry of a Blast	6-16
6.4.11. Series-in-Parallel	6-16
6.4.12. Parallel Circuits	6-20
6.5. Safety	6-20
6.5.1. General Safety Precautions	6-20
6.5.2. When Preparing the Primer	6-21
6.5.3. When Drilling and Loading	6-22

CHAPTER 7 MISCELLANEOUS BLASTING

7.0. Miscellaneous Uses of Explosives	7-1
7.1. Trenching	7-1
7.1.1. Vertical Wall Trenches	7-1
7.2. Cutting Timbers	7-1
7.3. Smooth Blasting	7-1
7.4. Presheering	7-2

CONTENTS

	PAGE
CHAPTER 8 TRANSPORTATION AND HANDLING	
8.0. Driver Qualifications	8-1
8.1. State License.....	8-1
8.2. Medical Examiner's Certificate	8-1
8.3. Explosives Driver Permit	8-1
8.3.1. Physical Requirements.....	8-1
8.3.2. Mental Requirements.....	8-1
8.3.3. Age and Experience.....	8-1
8.3.4. Alcohol and Drugs.....	8-1
8.3.5. Literacy and Comprehension	8-2
8.4. Training Requirements	8-2
8.5. Driver's Responsibility	8-2
8.5.1. Safe Driving Habits	8-2
8.5.2. Local Speed Regulations.....	8-2
8.5.3. Reckless or Drunken Driving.....	8-2
8.5.4. Disciplinary Actions and Penalties.....	8-2
8.5.5. Automatic Revocation of License.....	8-2
8.5.6. Reinstatement.....	8-2
8.6. Forms and Reports.....	8-2
8.7. Vehicle specifications	8-3
8.8. Vehicle Inspection and Loading.....	8-4
8.8.1. Before Loading.....	8-4

CONTENTS

	PAGE
8.8.2. Loading and Handling Regulations	8-4
8.9. Routes	8-5
8.10. Explosives Transporting Precautions	8-5
8.11. Security	8-5
8.12. Special Regulations	8-5
8.13. Accident Action Procedures.....	8-6
8.14. Breakdown Actions/Procedures	8-7
8.15. Burning Area Operations	8-7
8.16. Repack and Transfer of Cargo in Transit.....	8-7
8.17. Refueling a Loaded Vehicle.....	8-7
8.18. Parking a Vehicle When Loaded With Explosives	8-8
8.19. Delivery of Load.....	8-8
 CHAPTER 9 EXPLOSIVE STORAGE	
9.0. Classification system	9-1
9.1. Storage by Compatibility	9-1
9.2. Location of Magazines	9-1
9.3. Construction of Magazines	9-1
9.4. Magazine Operations	9-3
9.5. Destroying explosives.....	9-3
9.6. Disposal	9-3
 CHAPTER 10 BLASTING AND QUARRY STANDARD OPERATING PROCEDURES FOR NCF	
10.0. Purpose	10-1

CONTENTS

	PAGE
10.1. Site Approval.....	10-1
10.2. Explosive Limits.....	10-1
10.3. Personnel	10-1
10.4. Responsibilities.....	10-1
10.5. Communications.....	10-1
10.6. Equipment.....	10-1
10.7. Safety Summary.....	10-1
10.7.1. Prior to Conducting Operations	10-1
10.7.2. Preparing for Blasting.....	10-2
10.7.3. Bore Hole Loading Procedures.....	10-2
10.7.4. Safe Distance.....	10-2
10.7.5. Tie-in Procedures.....	10-2
10.7.6. Blast Initiation Procedures.....	10-3
10.8. Safety Do's and Don'ts—Instructions and Warnings	10-3
10.8.1. When Preparing the Primer	10-4
10.8.2. When Drilling and Loading.....	10-4
10.8.3. When Storing Explosive Materials.....	10-4
10.8.4. When Using Explosive Materials.....	10-5
10.8.5. When Blasting With Detonating Cord	10-5
10.8.6. When Blasting With Non-Electric Blasting Caps.....	10-5
10.8.7. Explosive Materials Disposal.....	10-5
10.9. Minimizing Hazardous Gas Products From Use of Explosive Materials.....	10-5
10.10. Handling and Use.....	10-6

CONTENTS

	PAGE
APPENDIX	
A. Drilling Log	A-1
B. Blasting and Quarrying Loading Record.....	B-2
C. Blasting and Quarrying Shot Record and Blasting Inventory	C-1
D. Blaster Explosive Log.....	D-1
AA. Transportation of Explosives	AA-1
BB. Misfire Procedures	BB-1
CC. Storage of Explosives	CC-1
DD. Securing the Quarry	DD-1
EE. Mishap Procedures	EE-1
FF. Safe Distance	FF-1
GG. Hazardous Material Handling Brief.....	GG-1
BIBLIOGRAPHY	

CHAPTER 1

GEOLOGY

1.0. ANALYSIS AND PROPERTIES OF COMMON ROCK. Within this manual a quarry is to be considered a facility to produce rock for construction operations. In general, the term rock refers to consolidated substances of the earth's crust that cannot be excavated without blasting or cutting. Rocks are conveniently classified into three groups, Igneous, Sedimentary and Metamorphic.

1.1. IGNEOUS ROCKS. Igneous rocks, which have been formed by the cooling and solidification of magma, comprise the first group. There are two different types, extrusive and intrusive.

- **Extrusive.** Extrusive igneous rocks are found when the magma is thrown out from the volcanoes or pushed slowly up through the cracks in the earth's crust. As the molten rock reaches the surface it usually spreads out and cools relatively rapidly resulting in small crystals or sometimes no crystals at all. Recently extruded lavas may contain long hollow tubes or tunnels.

- **Intrusive.** Intrusive igneous rocks are formed from deeply buried magmas that cool very slowly within the crust of the earth, thus forming larger crystals. There are three main types of intrusive masses. Smaller masses of a few square kilometers in surface area are called stocks. Tabular masses intruded between rock layers are called sills, and those that fill cracks or fractures, cutting across such layered structures are called dikes. All intrusive rock masses do not fit neatly into the three types and many times must be determined by detailed mapping or core drilling.

1.1.1. Common Igneous Rocks and Their Properties.

GRANITE.—An intrusive igneous rock with an even texture. Any light colored, coarse to medium grain rock may be called granite. Granite is gray, pink, or red, with crushing strength ranging from 15,000 to 30,000 pounds per square inch. Granite is found in all parts of the world and forms a large part of the continental masses. Unweathered granites are strong and durable rock suitable for bridge piers, sea walls, and foundations of buildings. Its chief defect lies in the fact that when heated and chilled, the quartz and feldspar grains expand or contract at different rates sometimes causing the rock surface to crumble or peel.

DIORITES.—A family of rocks that resemble dark granite, and are most often found in sills, dikes, and small stocks. Unweathered diorites are strong and durable, and have an average compressive strength of 28,000 pounds per square inch.

GABBRO.—A dark gray, green or black granular rock similar in appearance to diorites. Like granite, gabbro is found in batholiths, but it also forms small stocks, dikes, sills, and volcanic necks. Gabbro which is a durable construction material for all purposes, has a high degree of compressive strength (average is 26,000 psi), and low absorbability. Gabbro is chiefly used for road materials.

FELSITES.—A group of very dense, fine grained extrusive igneous rocks. They have dull, stony textures and are composed of quartz and feldspars. Colors range from light or medium gray to pink, brown, yellow, buff, purplish, and light green. Weathering causes felsite to become brown, rusty and crumble, eventually breaking down completely to become clay. Felsites are generally used as concrete aggregate.

BASALTS.—A group of very dense fine grained igneous rocks whose colors range from black to dark

gray to green to purplish. All basalts contain a great deal of lime, magnesium, and iron. They are a fine grained equivalent of gabbro and closely related to the andesites.

1.1.2. Engineering Properties of Igneous Rocks.

All intrusive rocks, when fresh and unweathered have high crushing and shearing strengths and unless fractured too small, are satisfactory for all types of engineering construction operations. They often provide an excellent source of concrete aggregates and other types of construction materials. Extrusive igneous rocks require extensive examination before their engineering characteristics can be determined. Many lava's are as satisfactory as intrusive rock, but the pyroclastic material may be unreliable.

1.2. SEDIMENTARY ROCK. Most sedimentary rocks result either directly or indirectly from weathering. They consist of hardened or cemented layers of sand, clay, and lime. The two major types of sedimentary rocks are chemical sediments, and clastic sediments. Chemical sediments are formed by material that has been transported in solution and later precipitated. Clastic sediments are formed by mechanical transportation (wind, water, glacial action, etc.) and deposition.

- **Chemical Sediments.** Limestone and dolomite are the most wide spread of the chemically precipitated rocks, and the dense varieties of these carbonate rocks have high crushing and shearing strength. Their principal defects are solution cavities formed during past geologic time. Other chemically precipitated sediments (chert, flint, rock salt, anhydrite, coquina, caliche, and soft coral) are unsatisfactory for most engineering purposes due to their solubility, chemical reactivity, or low physical strength.

- **Clastic Sediments.** Are formed of fragments of other rock, transported from the original sources. These sediments may be cemented to form firm rock by a variety of materials, the most important being oxides, carbonates, and silica.

1.2.1. Common Sedimentary Rocks and Their Properties.

LIMESTONE.—Any rock that contains more than 50 percent calcium carbonate in the form of calcite are considered limestones. When pure, limestones are

white or cream colored, but they are usually colored gray to black by carbon or stained buff, yellow, red, or brown by iron oxides. As a building stone it is used in both inner and outer walls and in floors and foundations, bridges, and a variety of other structures. Crushed limestone is used in the manufacture of Portland cement.

DOLOMITE.—Although similar in appearance and usage to limestone, dolomite is a calcium magnesium carbonate of varying proportions.

CHERT and FLINT.—Siliceous sediments are usually found in limestone and shale. They are very hard and difficult to drill. Chert can be used as a satisfactory road material.

ROCK SALT and ANHYDRITE.—Very abundant, soluble in water, and very soft. Rock salt deposits are of no value as a construction material.

CONGLOMERATES.—Composed of cemented gravel of varying sizes. Breccia (conglomerates composed of cemented angular fragments) may be used for road material if properly graded or crushed to size. It is usually susceptible to rapid weathering and consequent weakness.

TILL.—Consists of a heterogeneous group of materials that have been deposited by glaciers. Till is an excellent source of material for earth dams and embankments, but usually not suitable for concrete and bituminous aggregates.

SANDSTONE.—Consists of small grains (1/16mm to 2mm) that have been cemented together to form rock. The color of sandstone depends on the nature of the cement. Iron oxides give the red, yellow, and brown shades. Sandstone that splits easily into even slabs is known as flagstone commonly used as a decorative building material.

SILTSTONE.—Similar to sandstone, but composed mainly of cemented particles that are between 1/256 and 1/16mm in diameter.

CLAYS and SHALES.—Are made up of clay minerals, various oxides, Silica, fine particles of ordinary minerals, and a greater or lesser amount of colloidal and organic material

1.2.2. Engineering Properties of Sedimentary Rocks. The shearing resistance, crushing strength, and hardness of clastic sediments depends for the most part on the degree of consolidation and cementation.

1.3. METAMORPHIC ROCKS. These rocks are the result of profound changes in both igneous and sedimentary rock. There are two principal types of metamorphism, Igneous and Dynamic. Igneous is caused by direct contact with hot igneous rocks and the water, steam, and other gasses that come from them. Dynamic is caused by movement of the crust of the earth, compression, downward pressure, and the action of water providing the resulting rock changes go further than mere compaction and cementation.

1.3.1. Common Metamorphic Rocks and Their Properties.

GNEISS.—Gneiss is a banded rock of granite composition, containing quartz, feldspar, and mica. Their banded structure enables the rock to be split into more or less parallel surfaces allowing its use in the construction of tough walls and some road surfaces.

SCHISTS.—Schist has much finer texture than gneiss and possess a well marked cleavage. Unlike gneisses, their bands are mineralogically alike causing treacherous rock slips in quarries, rock cuts, and in tunnels if unsupported on steep or vertical faces.

SLATE.—Slate is a fine grained, hard, and dense rock, which was formed by the metamorphism of shale. It splits easily into thin layers which cut across bedding planes. The most important feature of slate is its cleavage which makes it valuable for roofing. Although not recommended, it can be used as a road material if absolutely necessary.

QUARTZITE.—For the most part, quartzite is metamorphosed sandstone. The grains of feldspar, hematite, chlorite, muscovite, and other minerals are present as impurities and give the rock a pink, brownish, or red brick color. Although similar in appearance to grainy limestones, quartzite's are much harder. Quartzite is not used as building stone due to shattering during jointing, but when crushed, become an excellent material for concrete work, railroad ballast, and road work.

MARBLE.—Marble is the result of the

metamorphism of limestone and dolomite. When crushed and used as an aggregate, marble has the same value as limestone.

1.3.2. Engineering Properties of Metamorphic Rocks. It is impossible to generalize the engineering properties of metamorphosed rocks. Most gneisses are hard and tough and have high crushing and shearing strengths. Most schists are highly anisotropic and attention should be given to their cleavage orientation. Also, many schists are very soft and unusable for high unit loading.

1.4. IDENTIFICATION OF COMMON ROCKS.

1.4.1. Moh's Hardness Scale. Rocks that fall between 5 and 7 on the Moh's hardness scale (see chart A) are most suitable for construction use. Below 5 on the scale is too soft and above 7 is too hard to crush. This scale does not indicate an exact hardness. The number 9 is not three times as hard as the number 3. It only means that any mineral can scratch all those beneath it in the scale and can be scratched by all those above it. Two minerals of the same number will scratch each other.

1.4.2. Expedient Scale. In the absence of the Moh's scale, a hardness test can be done in the field using the Expedient Scale. This is a simple test, if a file scratches the rock, the rock is below 6.5 hardness. If the rock scratches the file, the rock is above 6.5 hardness. If the rock scratches a knife blade or glass, but not the file, the rock hardness is between 5.5 and 6.5.

1.4.3. Taste Test. Most minerals that are readily soluble in water have a distinctive taste, Halite, for instance, can be identified quite easily because of its salty taste. A good rule of thumb to follow is, if it tastes salty, it is not good for construction. It will erode quickly.

1.4.4. Color. The color of a mineral is not always a dependable guide, since some minerals, quartz for example, occur in a bewildering array of color without any perceptible change in their composition. A few minerals are reasonably constant in their color and in these cases color can be considered, more or less, an identifying property.

1.4.5. Tenacity. Tenacity is the term to describe the

behavior of a mineral when an attempt is made to break, hammer, cut, bend, or crush it. A mineral is *brittle* if it breaks or powders easily,

malleable if it flattens under the hammer, *tough* if its resistance to being torn apart under a blow or great strain, *flexible* if it bends and remains bent after the pressure is released, and *elastic* if when bent it recovers its original position upon release of pressure.

1.4.6. Acid Test This test is used most effectively in the identification of carbonates. Any acid plus a carbonate will produce an effervescent reaction. Hydrochloric acid is the most common used.

Chart A

Moh's Scale of Hardness

Talc-----	1
Gypsum-----	2
Calcite-----	3
Flourite-----	4
Apatite-----	5
Feldspar-----	6
Quartz-----	7
Topaz or Beryl-----	8
Corundum-----	9
Diamond-----	10

Expedient Scale

Steel file-----	6.5
Knife blade or window glass-----	5.5
Copper coin-----	3.0
Fingernail-----	2.5

CHAPTER 2

QUARRY SELECTION

2.0. SITE SELECTION. Prior to quarry development, a site selection process must be conducted to insure that the expected quality and quantity of construction materials will be obtainable. Following site selection, quarry layout considerations are necessary to insure efficient operations. For clarification purposes, the term quarry (and pit) refers to sites where open excavations are made for the purpose of removing rock for use in construction projects. The distinction between pits and quarries is based on the manner in which the site is excavated. Pits are sites from which materials can be removed, generally without blasting. Quarries usually require drilling, cutting, or blasting for the excavation of the materials.

2.1. AREA RECONNAISSANCE. Proper site selection will begin with area reconnaissance of the proposed site. Site reconnaissance is divided into preliminary reconnaissance and field reconnaissance. Preliminary reconnaissance is the collection and study of all information relative to possible sites before going into the field. Field reconnaissance is a preliminary investigation involving one or more trips to potential sites for the purpose of obtaining information without subsurface excavation.

CAUTION: One factor that must be considered in proper site selection is the required safe distance from roadways, buildings, structures and local inhabitants. This safe distance is dependent upon the maximum blasting charge to be used in the quarry operations and will be calculated as 1.5 feet times the net explosive weight (NEW) or a minimum of 1500 feet, whichever is greater (see Chapter 10, (10.7.4.), for example calculations).

2.1.1 Preliminary Reconnaissance. Only areas considered to have definite possibilities should become

candidates for a thorough preliminary reconnaissance. As many sources of reliable data as possible should be used in formulating the reconnaissance plan. Some of the more common sources are listed below.

INTELLIGENCE SOURCES.—Intelligence gathering may be of two types:

- **Strategic.** Information on soil types, rock formations, and on location of existing quarries is included in strategic intelligence reports published by the Defense Intelligence Agency and the Central Intelligence Agency. These are important sources for long range planning from which reconnaissance plans for a given sector can be made prior to entering the area. Strategic engineer analyses prepared by the Naval Facilities Engineering command and the engineer sections of specified and unified commands are also good sources of information.
- **Tactical.** Intelligence reports compiled by intelligence and reconnaissance officers at all echelons are excellent sources of information on terrain and potential quarry sites. Units located in an area of interest can also serve as a source of information and should be contacted if possible

MAPS.—Geologic and topographic maps, and special aerial photographs, are all excellent aids in finding potential quarry locations. Such maps reveal information on existing quarry locations, geologic formations that lie beneath the surface, location of existing streams, roads, railway cuts, cliffs, routes of communications, and other pertinent features, i.e., folds, faults, and joints. When a topographic map is used together with a geologic map, interpretations can often be made that could not be made by using either map alone. When the maps themselves do not present a complete or up-to-date picture of the area of immediate

interest, or when geologic and topographic maps are not available, aerial photographs should be requested. Aerial photographs are most reliable when used in conjunction with other information or with ground visitation. Often aerial photographs may be the only source of information.

LOCAL INHABITANTS.—These persons, particularly surveyors, engineers, miners, contractors, and quarrymen, may provide much useful data on local geology and engineering problems that may be encountered. Farmers are a good source of information as they are familiar with outcroppings on their land.

MISCELLANEOUS RECORDS.—In areas where drilling has been conducted for wells or mine shafts, records normally are available showing locations and results of the exploration. These records will be a valuable source of information.

2.1.2. Field Reconnaissance. Following the geologic research conducted during the preliminary reconnaissance, a geologic field reconnaissance is conducted at the site under consideration for quarry development. During field reconnaissance, records should be made on map overlays of all the geologic and topographic features that may have a bearing on the suitability of the potential of the quarry site. It is essential to obtain as much information as possible on land forms, soil types and thickness, ground water conditions, bedrock types and structure, volume of construction materials, etc. Techniques of conducting field reconnaissance usually include subsurface borings, probings, wash borings, core drilling, wagon and jack hammer drilling, and excavator test pits and trenches.

2.2. SITE EVALUATION. From the samples taken a quality and quantity determination must be made of the construction materials for their intended use.

2.2.1. Quality. Conventional geologic assessment techniques to determine hardness, toughness, and durability ratings of the materials should be conducted.

2.2.2. Quantity. A determination of the quantity of the quarry material is important. Such a determination considers the type of material found, the in place and broken pounds per cubic foot, cubic feet per ton, and tons per cubic yard. Refer to Chart B for weight of rocks.

2.2.3. Other Evaluation Factors. To determine the most suitable site, the requirements of quality and quantity must first be met. If more than one site satisfies these requirements, then other factors, i.e., extent of ground and surface water, location, extent of overburden, utilities (electricity, water, and communications), equipment, training, and security should be considered in the final decision.

2.2.4. Existing Sites. Whenever possible, an existing site should be used. For existing pits and quarries, the quantity and quality of the material are easily determined. Existing sites generally reduce work required to remove overburden and are located near haul roads with access roads already constructed. Additionally quarries may be found with some equipment and facilities available for use.

2.3. CLASSIFICATION. Quarries are classified according to the type of material contained in them and the methods of obtaining the materials as outlined below:

2.3.1. Hard Rock.

Type:----- Granite, trap, schist, gneiss, etc.
Material:----- Aggregate.
Primary use:-- Base courses, surfacing and aggregate
for concrete and bituminous mixes.
Water condition:----- Dry.

Operations &
equipment:---- Drilling tools, blasting, loaders or
power shovel, crushing, screen-
ing and washing plant.

2.3.2. Medium Rock.

Type:---- Some limestone, some sandstone, etc.
Material:----- Aggregate.
Primary use:---- Base courses, surfacing.
Water condition:----- Dry.

Operations &
equipment:----Drilling tools, blasting, loaders or
power shovel, crushing, screening
and washing plant.

2.2.3. Soft Rock.

Type:----- Soft coral, tuff caliche, chalk, some
sandstone laterites, etc.

Material:----- Cementaceous material.
 Primary use:-- Base courses, surfacing on roads and
 airfields.
 Water condition:----- Dry.

Operations &
 equipment:----- Ripper, power shovel, front loader,
 earth moving equipment.

Chart B

Weight of Rocks

Material	Pounds per Ft.		Ft. per Ton		Tons per Yard		
	In Place	Broken	In Place	Broken	In Place	Broken	Swell
Andesite	181	97	11.1	20.6	2.44	1.31	1.75
Basal	181	97	11.1	20.6	2.44	1.31	1.75
Diabase	187	94	10.6	21.3	2.52	1.27	1.75
Diorite	187	94	10.6	21.3	2.52	1.27	1.75
Gneiss	168	96	11.9	20.8	2.27	1.30	1.75
Granite	170	97	11.8	20.6	2.30	1.31	1.74
Limestone	168	96	11.9	20.8	2.27	1.30	1.75
Porphyry	170	97	11.8	20.6	2.30	1.31	1.74
Rhyolite	150	86	13.4	23.3	2.02	1.16	1.75
Quartzite	165	94	12.1	21.3	2.23	1.27	1.74
Sandstone	151	86	13.2	23.3	2.04	1.16	1.76
Schist	168	91	11.9	22.0	2.27	1.23	1.75
Shale	175	95	11.4	21.1	2.36	1.28	1.85
Slate	175	95	11.4	21.1	2.36	1.28	1.85

CHAPTER 3

QUARRY LAYOUT AND DEVELOPMENT

3.0. QUARRY LAYOUT. Layout of a quarry consists of preplanning the shape, directions, and dimensions that are most desirable in its development. In many cases layout cannot be accomplished without simultaneous consideration of development. The two are closely related. Factors which may be considered in layout are:

- The mission.
- Structural geology of the rock source.
- Overburden.
- Equipment limitations.
- Access.
- Gravity flow.
- Positioning of equipment.
- Traffic patterns.

3.1. DETERMINING THE DIRECTION OF THE FACE. Prior to determining layout of the quarry, it is necessary to determine the quarry face.

- **Steeply Inclined and Folded Strata:** The quarry face must be oriented perpendicular to the strike in these types of strata as shown in figure 1. If the rock is worked in this manner, a vertical or near vertical face will result. If the face is oriented parallel to the strike, an overhanging or sloping face with an extended toe will result. These conditions are hazardous and inefficient (fig. 2).
- **Level and Slightly Inclined Stratum and Massive Rock Formations:** Where conditions of level stratum or massive rock formations exist, the direction of the quarry face may be determined by other factors if

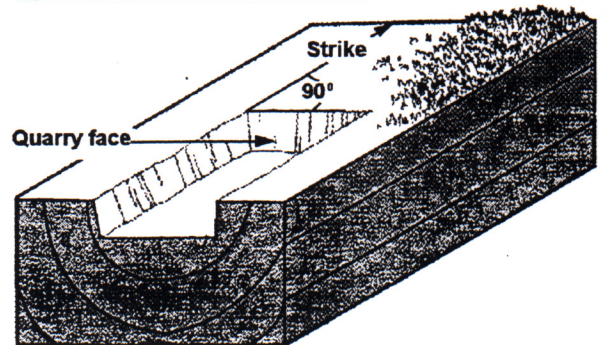
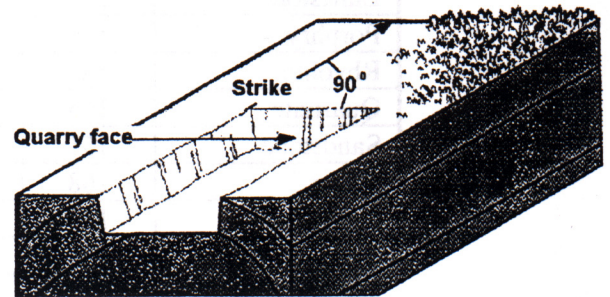
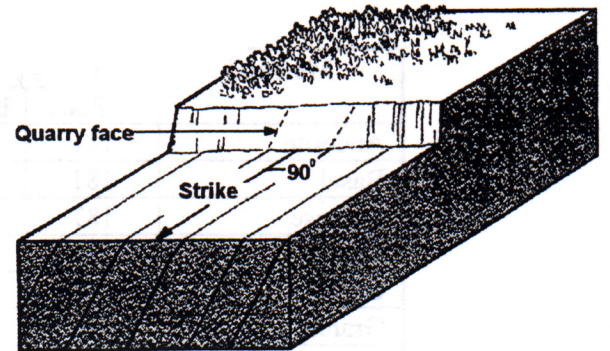

Folded stratum
(Syncline)

Determining direction of face

Figure 1

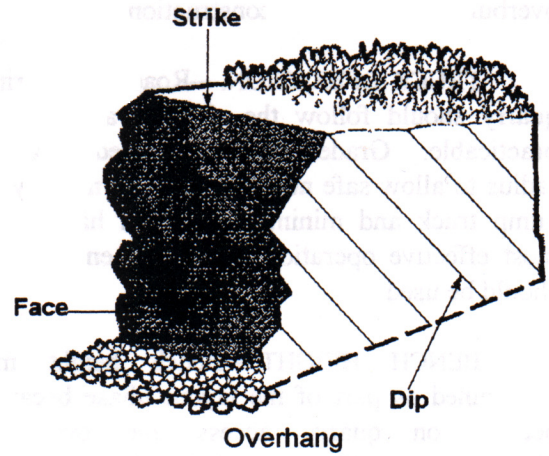
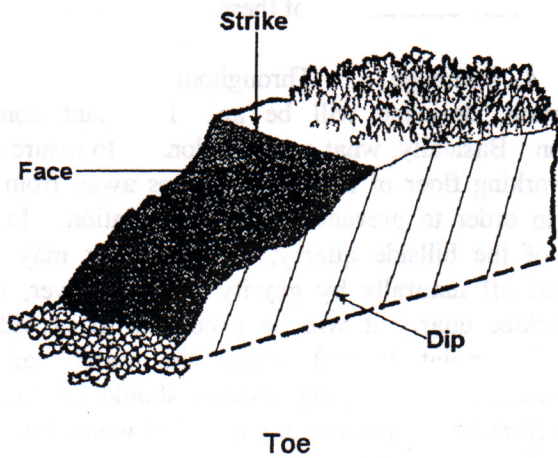

Disadvantage of opening face parallel to strike.

the strata at the proposed quarry site are slightly inclined, the quarry face should be worked up the grade so that the floor of the quarry will slope away from the face (fig 3).

3.2. TYPES OF QUARRIES. The three basic quarry types are hillside, subsurface, and terrain:

HILLSIDE QUARRY.—As the name implies, this type of quarry is operated in rock which is part of the structural geology of a hill. Problems which may be encountered are overburden removal, grades, and multiple bench operation. Hillside quarries have the advantage of natural drainage and gravity flow of material from the quarry face.

SUBSURFACE QUARRIES.—A subsurface quarry is one which is opened up below the level of the surrounding terrain. The requirements to remove material (overburden and actual rock excavation) from below grade and dispose of it above grade are the basic disadvantages. In addition, subsurface quarries will not drain naturally, requiring

Figure 2

periodic pumping.

TERRAIN QUARRY.—This type is a temporary operation whereby the existing terrain is lowered and/or leveled. An example is the excavation needed to cut a roadway through a rock formation.

3.3. OTHER CONSIDERATIONS FOR QUARRY LAYOUT:

OVERBURDEN.—In planning the layout of a quarry, the primary aspect of overburden removal which needs to be considered is the location (spoil area) to be used for overburden disposal. Overburden should be disposed of in a location where it will not be necessary to handle it a second time. For safety reasons, overburden should not be piled within 50 feet of the quarry rim. Other considerations may be the relationship of spoil areas to drainage plans and the possible use of

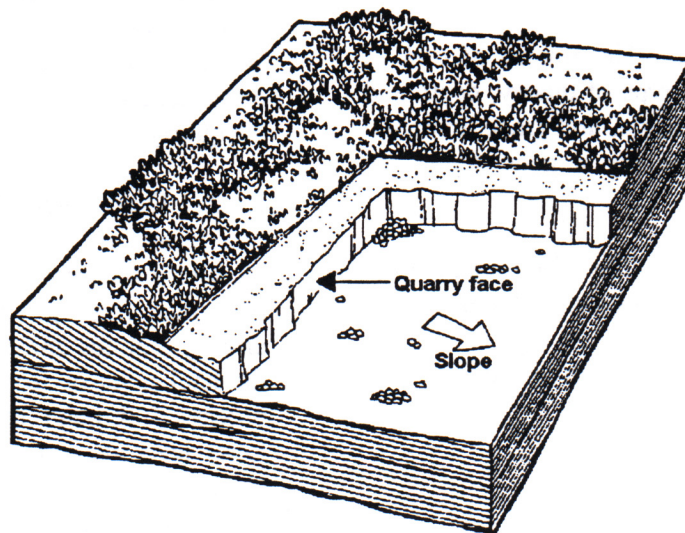

Quarry face on slightly inclined strata showing underlying stratum used as quarry floor and slope away from quarry face.

Figure 3

overburden material for construction.

TRUCK OPERATION.—Roads to the rim of the quarry should follow the shortest and easiest route practicable. Grades must be limited to a sufficient radius to allow safe negotiation at 20 mph by a loaded dump truck and minimize delay in hauling. For the most effective operation a separate entrance and exit should be used.

BENCH HEIGHT.—Bench height must be determined as part of the layout phase because of its bearing on quarry access and overall quarry dimensions. The normal bench height for NCF quarries is 12 feet. Bench height may vary depending on local conditions.

DETERMINING THE LEVEL AND DIMENSIONS OF QUARRY FLOOR.—Level refers to the number of benches. The quarry floor is the ultimate bottom of the quarry. Both are determined by the geologic factors, rock requirements, and area restrictions.

1. **Geologic Factors.** Geologic factors which may limit the depth of a quarry are the depth of the water table and the thickness of usable material. It may be possible to work below the water table, but if this is done, definite and effective plans must be made to control the amount of water in the quarry throughout the operation.

2. **Rock Requirements.** The amount of rock to be excavated will determine; type of quarry, depth and dimension of quarry, bench height, and grade limitation to be developed (10% is usually a good figure for trucks).

3. **Area Restrictions.** The determination of surface dimensions should take into consideration;

- The optimum length and width for minimum overburden removal.
- Boundary limitations
- Proximity of inhabited dwellings or other structures subject to damage from blasting or,

- Any combination of these

4. **Drainage.** Throughout the quarrying operation, drainage will be an important consideration. Basically, what must be done is to insure that the working floor of the quarry slopes away from the face in order to prevent water accumulation. In the case of the hillside quarry, surface water may be drained off naturally by gravity flow, however, in a subsurface quarry it will be necessary to provide a collection point (sump) where the water can be accumulated for pumping. Sumps should be located away from traffic areas or any area that would interfere with efficient operation.

3.4. QUARRY DEVELOPMENT. With a working knowledge of geology and completion of site selection, evaluation, and layout resulting in an appropriate quarry site expected to yield the quantity and quality of building materials desired, the next step is to develop (or work) the quarry. The development of a quarry consists of continuing work to achieve the desired layout including the construction of access roads, installation of the crushing and screening plants, the establishment of the equipment maintenance site, removal of overburden, development of the quarry face and floor and rock excavation operations (drilling and blasting).

3.4.1. Starting Work. Work should be started on the installation of the crushing and screening plant as soon as possible after the site becomes accessible. Work should progress simultaneously with the construction of the quarry access road and opening of the quarry.

3.4.2. Dual Level Crusher Operations. Usually two levels are used for crushing operations, which requires a retaining wall or a vertical or nearly vertical rock face (fig 4). The quarry-run rock is dumped directly onto the apron feeder or into a loading chute by the haul units or front end loader on the upper level, processed through the plant and discharged on the lower level via conveyor belts. For short durations the single level operation could be used. In this manner the rock could be dumped onto the ground and lifted to the apron feeder by a clamshell. However, this method is far less

efficient, and normally results in increased safety hazards.

3.4.3. Rock Crusher Site Preparation. Site preparation for the plant will consist of the following basic steps:

a. **Preliminary Earthwork.** The lower level of the site is cut to grade and proper dimensions. Material taken from the lower site can be used as backfill behind the retaining wall. The excavation for the retaining wall anchorage may also be done at this time .

b. **Construction of Anchorage.** The anchorage may be constructed as soon as the excavation is completed. This may involve the emplacement of large logs or the construction of forms and pouring of concrete for a heavier anchorage.

c. **Retaining and Wing Wall Construction.** When earthwork on the lower level is complete, the retaining wall can be erected. Support for the retaining walls may be provided by driven piles. Holes may be drilled and piles individually set in concrete, or the base of the wall may be entrenched and piles set in a continuous concrete footer.

3.4.4. Stationing the Plant. For short duration jobs, the crusher can be operated on the wheelbase with minimum jacking to reduce vibration. But on longer jobs the plant must be jacked and cribbed clear of the ground on 12x12 inch timbers or a suitable material. Each manufacturer specifies setup procedures.

3.4.5. Hopper Extensions. Extensions may be welded to the hopper in order to increase the width to accommodate the loading units.

3.4.6. Loading Chute. A loading chute can be used if the retaining wall or a usable bench higher than 18 feet is used. If a grizzly is desired then a bench must be constructed high enough to accommodate the chute and grizzly (fig 5). For very high crusher retaining walls,

the use of the inclined chute will allow equipment to work at a greater distance from the edge of the retaining wall, thus reducing the earth pressure against it. Whenever chutes, bins or hoppers are used they should be kept approximately 1/3 full so that impact of falling rock can be

absorbed without damage to the structure or equipment.

3.4.7. Grizzlies. Grizzlies are coarse screens for sizing quarry run rock prior to crushing. They are made of a rigid rectangular frame with steel rails spaced at intervals determined by the jaw setting. As a rule of thumb, the optimum size rock fed to a crusher is 75 percent of the jaw dimensions. For a 20x36 inch jaw crusher this would be 15x27 inches. Grizzlies constructed of parallel bars without cross pieces would use a bar spacing of 75 percent of the small dimension or less. The screening bars of a grizzly without cross pieces are always sloped and oriented in the direction in which the oversized material is desired to be cast.

3.4.8. Maintenance Areas. Because of the nature of a quarry operation, the equipment is subject to extreme wear. Besides the normal repair and maintenance, hard facing will be required on the crusher jaws and rolls, and on loaders and dozers. The maintenance area should be located between the crusher site and the quarry for easy access and to avoid travel on primary roads with heavy equipment.

3.4.9. Access Roads. Before construction of the access roads, consideration must be given to the types of loads and the amount of traffic to use them. Normally the access road or a portion of it will be used as the haul road from the quarry to the crusher. Haul

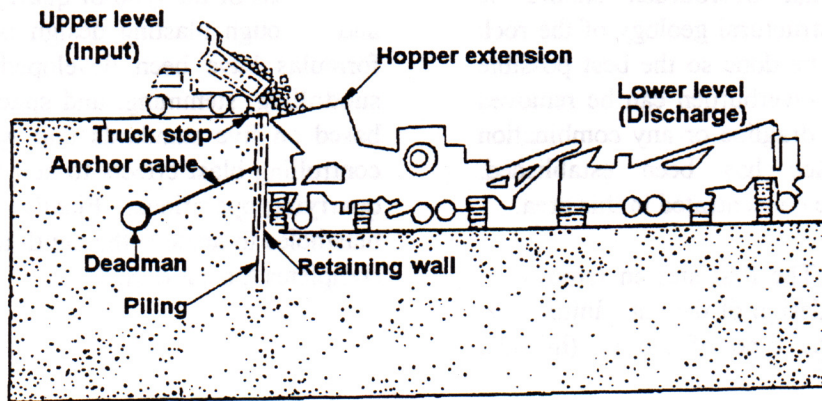

Crusher setup showing two working levels

Figure 4

roads should be surfaced with crushed rock and drain properly to reduce road maintenance. They should also be kept free of large rock to reduce wear to tires.

3.4.10. Overburden Removal. Overburden does not have to be completely removed before quarrying is started. However enough overburden should be removed to ascertain the structural geology of the rock formation. This needs to be done so the best possible face can be established. Overburden can be removed by bulldozer, scrapers, or dragline or any combination thereof. After the face has been established, overburden removal can be concentrated in this area.

3.5. CUT DESIGN. The first step in removal of rock from a quarry is the design of the cut. Initial cuts will be determined by the type of quarry (hillside,

subsurface, or terrain), under development, the predetermined bench height, the geologic characteristics of the rock and the capabilities of the loading equipment. The width and depth of material to be taken out of a bench in any one blast is called the cut. The first step in designing the cut is blasting design. Regardless of the type of quarry and design of the cut, and although blasting design is not an exact science, formulas have been developed to determine burden, subdrilling, stemming, and spacing. The formulas are based on five standards that will provide a means of controlling blast effects to suit the requirements of the quarrying operations. Finally, the arrangement of the blastholes to achieve the depth and width of cut desired completes the cut design.

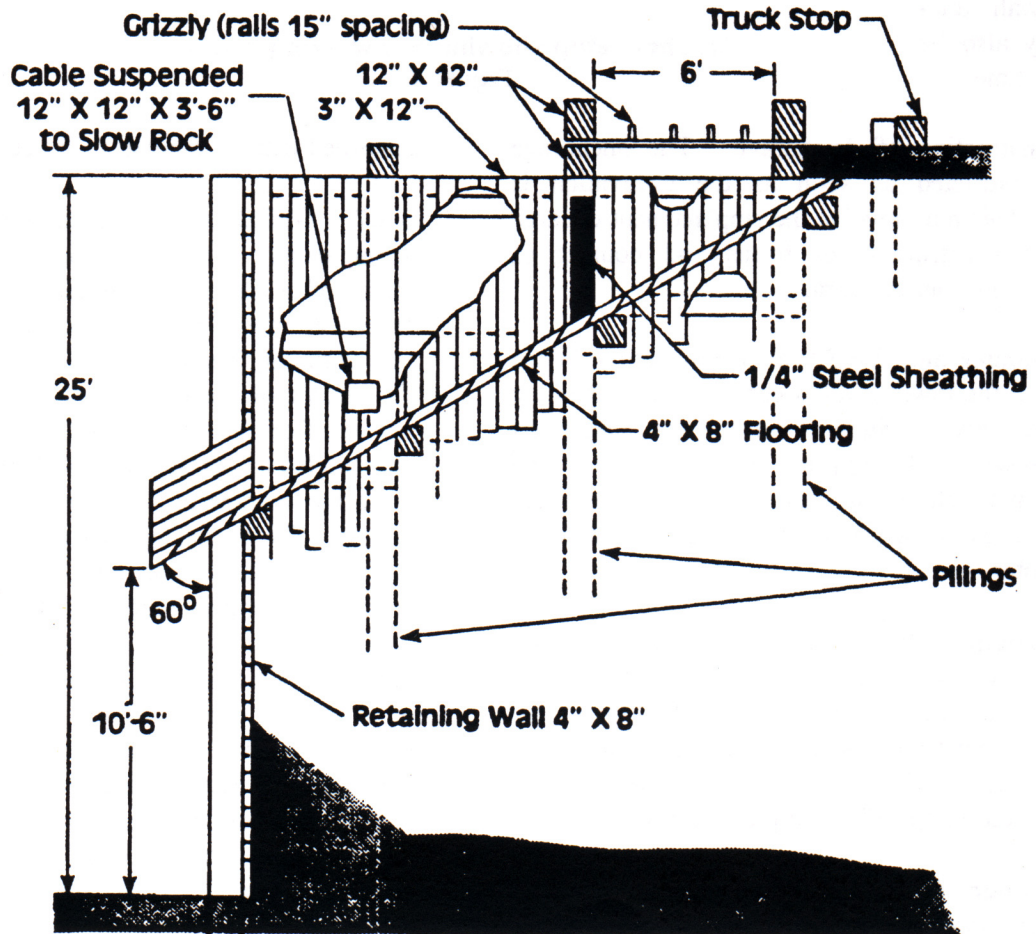

SECTION A-A

Loading chute with grizzly

Figure 5

CHAPTER 4

BLAST DESIGN

4.0. BLASTING DESIGN. The first step in designing the cut is to design the blasting such that the blast effects are controlled to suit the requirements of the operation. Knowledge of mathematical formulas will provide ease in designing a blast that will be safe as well as effective. A common way of designing a blast is using the Powder Factor method.

4.1. POWDER FACTOR. The powder Factor is a common term used frequently in blasting operations and means simply the number of pounds of explosives necessary to break a certain quantity of rock. For example, if a blaster uses 1,000 pounds to break 1,000 cubic yard of rock, his Powder Factor is 1 pound per cubic yard. The Powder Factor term is very general and does not define the distribution of the explosive in the hole, the pattern, hole size or face height and subdrilling. Normally, the subdrilling is not included in the yardage or tonnage figure because it is not pay rock.

4.2. POWDER FACTOR PROCEDURES. Determine total explosive per hole as follows:

- a. Determine borehole diameter.
- b. Determine borehole depth.
- c. Determine Stemming (24 x borehole diameter). Divide by 12 to get the number of feet of stemming.
- d. Determine subdrilling ($1/3$ x stemming).
- e. Determine powder column (amount of hole to be loaded). Borehole depth plus subdril-

ling minus stemming.

f. Determine pounds of explosive/foot of powder column. Use Chart C. or, use formula: Diameter squared x 0.34 x specific gravity of explosive. Note: Blasters must know the explosive densities of the explosive they are using to use this chart C.

g. Determine total load for the borehole. Powder column times step (f) (pounds of explosive per foot of powder column). Find the pattern that borehole load can break.

h. Divide the total load by the borehole depth. This will equal the number of cubic yards per foot of borehole that can be broken.

i. Determine the approximate square pattern from Chart C or multiply the number obtained in step (h) by 27 and take the square root of this to determine the square pattern. This procedure was written for free running explosives. You must also use the chart on pg 482-483 of the Dupont Blasters Handbook.

j. Adjust to a rectangular pattern of the same total cubic yards.

k. Adjust stemming and subdrilling if it appears necessary.

NOTE:

FOR POWDER FACTOR OTHER THAN 1 POUND PER CUBIC YARD, DIVIDE THE NUMBER OF CUBIC YARDS OBTAINED IN STEP (h) BY THE POWDER FACTOR DESIRED.

4.3. DRYING BOREHOLES. Some boreholes may contain water. Explosive cartridges can be

Chart C
Loading Densities (lb./ft.³=3405 Den. x Dia.²)

Col. Dia. Inches	Pounds of Explosive per Foot of Powder Column for Given Densities (g/cc)																
	0.80	0.82	0.85	0.90	0.95	1.00	1.05	1.10	1.15	1.20	1.25	1.30	1.35	1.40	1.45	1.50	1.60
1	0.27	0.28	0.29	0.31	0.32	0.34	0.36	0.37	0.39	0.41	0.43	0.44	0.46	0.48	0.49	0.51	0.54
1 1/4	0.43	0.44	0.45	0.48	0.51	0.53	0.56	0.59	0.61	0.64	0.67	0.69	0.72	0.74	0.77	0.80	0.85
1 1/2	0.61	0.63	0.65	0.69	0.73	0.77	0.80	0.84	0.88	0.92	0.96	1.00	1.03	1.07	1.11	1.15	1.23
1 3/4	0.83	0.86	0.89	0.94	0.99	1.04	1.09	1.15	1.20	1.25	1.30	1.36	1.41	1.46	1.51	1.56	1.67
2	1.09	1.12	1.16	1.23	1.29	1.36	1.43	1.50	1.57	1.63	1.70	1.77	1.84	1.91	1.97	2.04	2.18
2 1/4	1.38	1.41	1.47	1.55	1.64	1.72	1.81	1.90	1.98	2.07	2.15	2.24	2.33	2.41	2.50	2.59	2.76
2 1/2	1.70	1.74	1.81	1.92	2.02	2.13	2.23	2.34	2.45	2.55	2.66	2.77	2.87	2.98	3.09	3.19	3.40
2 3/4	2.06	2.11	2.19	2.32	2.45	2.57	2.70	2.83	2.96	3.09	3.22	3.35	3.48	3.60	3.73	3.86	4.12
3	2.45	2.51	2.60	2.76	2.91	3.06	3.22	3.37	3.52	3.68	3.83	3.98	4.14	4.29	4.44	4.60	4.90
3 1/4	2.88	2.95	3.06	3.24	3.42	3.60	3.78	3.96	4.14	4.32	4.50	4.68	4.86	5.03	5.21	5.39	5.75
3 1/2	3.34	3.42	3.55	3.75	3.96	4.17	4.38	4.59	4.80	5.01	5.21	5.42	5.63	5.84	6.05	6.26	6.67
3 3/4	3.83	3.93	4.07	4.31	4.55	4.79	5.03	5.27	5.51	5.75	5.99	6.22	6.46	6.70	6.94	7.18	7.66
4	4.36	4.47	4.63	4.90	5.18	5.45	5.72	6.00	6.26	6.54	6.81	7.08	7.35	7.63	7.90	8.17	8.72
4 1/4	4.92	5.04	5.23	5.54	5.84	6.15	6.46	6.77	7.07	7.38	7.69	8.00	8.30	8.61	8.92	9.23	9.84
4 1/2	5.52	5.65	5.86	6.21	6.55	6.89	7.24	7.58	7.93	8.27	8.62	8.96	9.31	9.65	10.00	10.34	11.03
4 3/4	6.15	6.30	6.53	6.91	7.30	7.68	8.07	8.45	8.83	9.22	9.60	9.99	10.37	10.76	11.14	11.52	12.29
5	6.81	6.98	7.24	7.66	8.09	8.51	8.94	9.36	9.79	10.22	10.64	11.07	11.49	11.92	12.34	12.77	13.62
5 1/4	7.51	7.70	7.98	8.45	8.92	9.38	9.85	10.32	10.79	11.26	11.73	12.20	12.67	13.14	13.61	14.08	15.02
5 1/2	8.24	8.45	8.75	9.27	9.78	10.30	10.82	11.33	11.84	12.36	12.88	13.39	13.91	14.42	14.94	15.45	16.48
5 3/4	9.01	9.23	9.57	10.13	10.69	11.26	11.82	12.38	12.95	13.51	14.07	14.63	15.20	15.76	16.32	16.89	18.01
6	9.81	10.05	10.42	11.03	11.64	12.26	12.87	13.48	14.10	14.71	15.32	15.93	16.55	17.16	17.77	18.39	19.61
6 1/4	10.64	10.91	11.31	11.97	12.64	13.30	13.97	14.63	15.30	15.96	16.63	17.29	17.96	18.62	19.29	19.95	21.28
6 1/2	11.51	11.80	12.23	12.95	13.67	14.39	15.11	15.82	16.54	17.26	17.98	18.70	19.42	20.14	20.86	21.58	23.02
6 3/4	12.41	12.72	13.19	13.96	14.74	15.51	16.29	17.07	17.84	18.62	19.39	20.17	20.94	21.72	22.50	23.27	24.82
7	13.35	13.68	14.18	15.02	15.85	16.68	17.52	18.35	19.19	20.02	20.86	21.69	22.52	23.36	24.19	25.03	26.69
7 3/8	14.82	15.19	15.74	16.67	17.59	18.52	19.45	20.37	21.30	22.22	23.15	24.08	25.00	25.93	26.85	27.78	29.63
7 1/2	16.89	17.32	17.95	19.00	20.06	21.12	22.17	23.23	24.28	25.34	26.40	27.45	28.51	29.56	30.62	31.67	33.79
8	17.43	17.87	18.52	19.61	20.70	21.79	22.88	23.97	25.06	26.15	27.24	28.33	29.42	30.51	31.60	32.69	34.87
8 1/2	19.68	20.17	20.91	22.14	23.37	24.60	25.83	27.06	28.29	29.52	30.75	31.98	33.21	34.44	35.67	36.90	39.36
9	22.06	22.62	23.44	24.82	26.20	27.58	28.96	30.34	31.72	33.10	34.48	35.85	37.23	38.61	39.99	41.37	44.13
9 1/8	26.56	27.23	28.22	29.88	31.54	33.20	34.86	36.52	38.18	39.84	41.51	43.16	44.83	46.49	48.15	49.81	53.13
10	27.24	27.92	28.94	30.64	32.35	34.05	35.75	37.46	39.16	40.86	42.56	44.26	45.97	47.67	49.37	51.07	54.48
10 5/8	30.75	31.52	32.67	34.60	36.52	38.44	40.36	42.28	44.21	46.13	48.05	49.97	51.89	53.81	55.74	57.66	61.50
11	32.96	33.78	35.02	37.08	39.14	41.20	43.26	45.32	47.38	49.44	51.50	53.56	55.62	57.68	59.74	61.80	65.92
12 1/4	40.88	41.90	43.43	45.99	48.54	51.10	53.65	56.21	58.76	61.32	63.87	66.43	68.98	71.53	74.09	76.64	81.75
12 1/2	42.56	43.63	45.22	47.88	50.54	53.20	55.86	58.52	61.18	63.84	66.50	69.16	71.82	74.48	77.14	79.80	85.12
15	61.30	62.80	65.10	68.90	72.80	76.60	80.44	84.27	88.10	91.94	95.77	99.60	103.43	107.30	111.09	114.90	122.60
17 1/2	83.40	85.50	88.60	93.90	99.10	104.30	109.50	114.70	119.90	125.10	130.40	135.60	140.80	146.00	151.20	156.40	166.80

used to displace the water in the boreholes, but it is advisable to pump the water out, or blow it out with air. When selecting an explosive keep in mind its water resistance. (Ammonium nitrate fuel oil (ANFO) mix is water soluble.) Cartridges must be used to fill the hole above the water level. As cartridges are added the water is displaced and rises. The formula for determining the resultant height of water is:

$$H = \frac{\frac{DxDxW}{h}}{\frac{DxD}{c}}$$

Where,

H = Resultant height of water in feet (where cartridges built out of water).

$\frac{DxD}{h}$ = Borehole diameter in inches squared.

W = Water in hole in feet (before loading).

$\frac{DxD}{c}$ = Cartridge diameter in inches squared.

4.4. BENCH HEIGHT. In some blasting operations the height of the bench must be known. A simple method of determining bench height that has been used for many years is with a 45 degree triangle. A mechanic's 45 degree triangle or a 45 degree triangle made of wood may be used. (If a wooden triangle is used, the bottom portion should be blocked in the horizontal position as determined by a carpenter's level).

By sighting along the slanting edge of the triangle to the quarry floor a point (B) can be located (fig 6). Measure from the lower point (A) to the point (B) on the quarry floor with a tape (AB). The line AB is the hypotenuse of a 45 degree right triangle. One leg of the triangle is line AC (the bench height) the other is BC (the base). The legs of a 45 degree triangle are equal. To determine AC, the height of the bench; multiply the distance AB by 0.71, the sine of a 45 degree angle.

4.5. TOE. The line CD in figure 6 is called the Toe. Toe is the unbroken lower part of a bench face that has been blasted but did not shear loose and move out. To measure toe, subtract the measured distance of line BD from the calculated distance BC (see bench height

above).

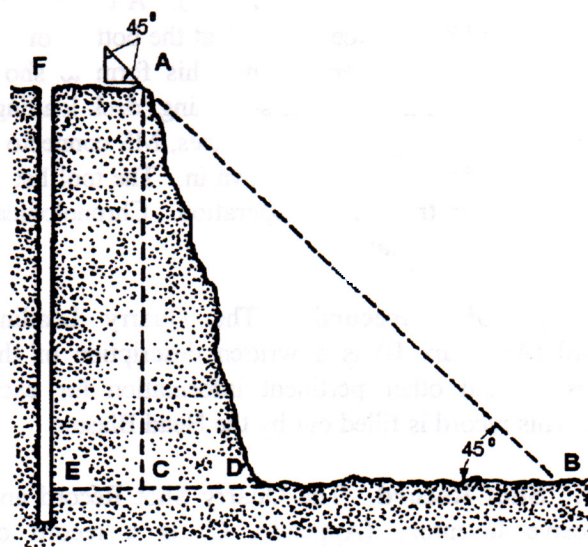

How to find the height of a quarry face

Figure 6

4.6. CUBIC YARDS AND TONS. To calculate cubic yards and tonnage use the following formulas:

Cubic Yards per Hole

$$= \frac{\text{Burden (ft.)} \times \text{Spacing (ft.)} \times \text{Hole Depth (ft.)}}{27}$$

Tons per Hole

$$= \text{Cu. Yds. per Hole} \times \text{No. of Tons per Cu. Yd.}$$

$$\text{Pounds per Cu. Yd.} = \frac{\text{Pounds of Explosive}}{\text{Cubic Yards of Rock}}$$

$$\text{Tons of Rock} = \text{Tons per Pounds of Explosives}$$

4.7. LOG BOOKS AND RECORDS. Formulation of quarry records is imperative due to the rotation of blasting crews and deployed units. The quarry records are kept a minimum of five years. One clear copy of the quarry record is kept at the quarry on file for future reference.

4.7.1. Drilling Records. Drilling records are important in respect to priming and loading, showing cracks and seams, type of material, and problems encountered drilling the boreholes. The Head Blaster gives the Head Driller the shot location, shot pattern, hole depths and any information from previous blasts helpful in drilling. After drilling the pattern the Head

Driller fills out the Drilling log (Appendix A) showing actual depth, cracks, seams and voids. A diagram of the pattern and bench face is drawn at the bottom of the page. The Head Blaster will use this form to show explosive location in the hole, stemming, deck loading, etc. On the shot diagram the trunklines, MS connectors and initiating devices will be drawn in. The tool list is for tools used in the blasting operation. Chronological time is kept for the blast.

4.7.2. Loading Record. The Quarry Loading Record (Appendix B) is a written description of the explosives and other pertinent information for each hole. This record is filled out by the Head Blaster.

4.7.3. Shot Record. The Quarry Shot Record and Explosive Inventory (Appendix C) is a record of explosives and general information. It provides future reference for information regarding a shot. The Quarry Shot Record and Explosive Inventory is filled out by the Head Blaster.

4.7.4. Explosive Log. The Blaster's Explosive Log (Appendix D) is a prior planning document and checklist used by the Head Blaster to manage the blast properly. A Head Blaster should not rely on memory to conduct any blasting operations. A written plan of the blast needs to be in the blaster's possession. The Blaster's Explosive Log provides that plan.

4.8. DRILLING PATTERNS. After the desired width and depth of cut have been determined, the drilling pattern may be selected. The patterns discussed in the following paragraphs are pertinent to both vertical and inclined holes. Selection of a drilling pattern should include consideration of the method of blast initiation to be used (delay or simultaneous).

4.8.1. Single Row Pattern.

- **Simultaneous Initiation.** This pattern is most desirable from the standpoint of maximum breakage and displacement per hole drilled because it allows for a greater spacing. Normally, there will be two nearly vertical free faces, the front and one side. The hole nearest the open side is drilled one burden distance from each face. Corner holes are drilled one burden

distance from the next hole and should be delayed to prevent backbreak or overbreak into the next bench. This delay may be accomplished with a delay cap or the hole(s) may be primed and initiated separately after the others.

- **Single-Row Delay Within Row.** This pattern requires more holes per width of face but gives the advantages of better fragmentation, less ground and air vibrations from the blast, and controlled throw of the broken material. The holes are initiated in sequence starting at the center and moving out in both directions at the same time in 0.025 second intervals with the exception of the corner hole which may be initiated separately at a longer delay as mentioned above. This initiation pattern will result in throw to the center. If the holes were to be initiated starting at the right and proceeding to the left, the throw would be to the right side of the face.

4.8.2. Multiple Row Patterns. Multiple row patterns are of three types, staggered, rectangular, and square, and generally require the use of delay caps or other delay devices.

- **Staggered Pattern.** The staggered pattern is used for simultaneous initiation of holes within a row and delays between rows. Throw is to the front with a small portion at the end of the bench being thrown off to one side. The staggered pattern may be used for simultaneous initiation of an entire layout consisting of not more than two rows of holes.

- **Rectangular Pattern.** Similar to the staggered pattern in spacing between rows and holes. The main advantage of this pattern is that it simplifies the maintenance of square corners on the bench by initiation of a delayed charge at the end of the row.

- **Square Pattern.** With the square pattern, throw can be directed toward the center or to the side by delayed initiation within rows. The volume of material obtained per hole using this pattern is nearly equal to that obtained in using the staggered pattern. The reason for this is that the spacing between rows is greater. The use of this pattern allows the maintenance of square corners with much greater ease than the staggered pattern.

CHAPTER 5

EXPLOSIVES AND INITIATING DEVICES

5.0. TYPES OF EXPLOSIVES AND INITIATING DEVICES THAT ARE USED BY THE NCF.

5.1. EXPLOSIVE TYPES.

5.1.1. M-1 Dynamite. The M-1 military dynamite is a Cyclotrimethylene Trinitramine (RDX) based composite explosive containing no nitroglycerin. The M-1 military dynamite is packaged in 1/2 pound, paraffin-coated, cylindrical paper cartridges which have a nominal diameter of 1.25 inches and nominal length of 8 inches. It will not freeze in cold storage nor exude in hot storage. The composition does not absorb or retain moisture. Shipping containers do not require turning during storage. It is safer to store, handle, and transport than 60 percent commercial dynamite. It is reliable underwater only up to 24 hours. Because of its low sensitivity, sticks of military dynamite must be well compacted to ensure complete detonation of the entire charge. There must not be any voids in loading of boreholes in quarrying. Military dynamite will eventually detonate if set afire in a confined space. Thus, a secondary explosion can result from a borehole with a void in its loading. After the first blast, it may take up to 15 minutes for such an explosion to occur.

5.1.2. Water Gel. The term 'WG explosives' will be used to describe water gel explosives. WG explosives prove to be much safer than dynamite, they contain no nitroglycerin, are sensitive to conventional priming methods, yet much more resistance than dynamite to accidental initiation from abusive impact, shock or fire. Some other advantages are:

- Greater control of borehole density. The borehole density of WG explosives can be greatly increased by slitting or tamping the cartridge.

- Excellent fragmentation.

- Minimized danger of hole to hole propagation.

- Reduced smoke and toxic fumes.

- Elimination of nitroglycerin effects.

- Water resistance.

WG explosives are packaged in a heavy rugged film in diameters from 1 1/2 to 4 inches, and lengths up to 16 inches. They are available in both cap sensitive and non cap sensitive.

5.1.3. Ammonium Nitrate (ANFO). Free running ammonium nitrate field mixes are ideal for use in highly jointed and dense material. The mixture ratio is critical to the sensitivity of the explosive. A field mix of 94 percent by weight of ammonium nitrate and 6 percent by weight of fuel oil (# 2 Diesel) or 50 pounds of ammonium nitrate uncoiled prills and 3 quarts of fuel oil will produce an insensitive explosive capable of filling all the voids in the hole. It must be used in 3-inch or greater diameter holes, confined and adequately primed to develop full strength. The use of blasting agents in 3-inch or greater diameter holes is desirable in dense material due to its low velocity. It is insensitive due to the lack of nitroglycerin in its composition, and therefore requires a high explosive primer.

5.1.4. Detonating Cord. Detonating cord is a core of Pentaerythritol Tetranitrate (PETN) or RDX in a textile tube coated with a thin layer of asphalt. On top of this is an outer textile cover finished with a wax gum composition or plastic coating. It will transmit a detonating wave from one point to another at a rate between 20,000 and 24,000 feet per second. A partially submerged water-soaked detonating cord will detonate if initiated from a dry end. Although it does not lose its explosive properties by exposure to low temperatures, the covering becomes stiff and cracks when bent. Great care is required in using detonating cord primers in Arctic conditions. Detonating cord can

be used to prime and detonate other explosives charges. When its explosive core is detonated by a blasting cap or other explosive device, it will transmit the detonation wave to an unlimited number of explosive charges.

5.1.5. Detaprime. The development of ANFO products and WG explosives created a need for high-velocity, high energy primers. To meet this demand, compact, high-detonation pressure non-nitroglycerin primers were developed. These non-nitroglycerin primers are more resistant to acci-

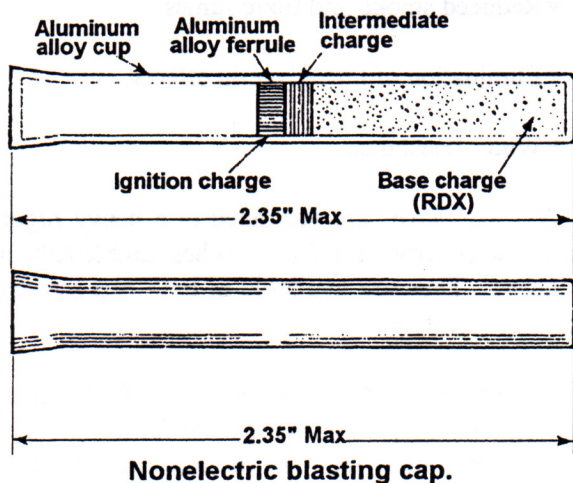

energy, flame, friction or impact during normal use. NONEL requires no knowledge of electric circuitry.

5.2.2. Electric Blasting Cap. The electric blasting cap has a cylindrical metal shell containing several powder charges (fig 7). Electrical energy is delivered into the cap by two plastic-insulated, metal wires called "leg wires", which enter the cap through a

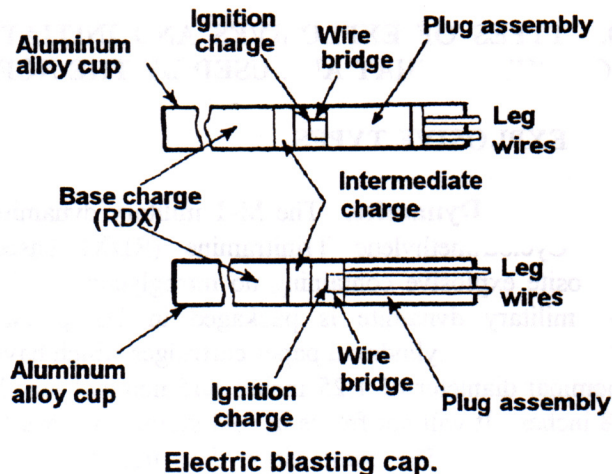

Figure 7

dental detonation from impact, shock, or friction than dynamite, but should be handled in the same safe manner as other explosives.

5.2. INITIATING DEVICES. Because all initiating devices are made to explode, they should be treated with the same care and caution used with all high explosives. They should not be physically abused, tampered with or altered in any manner or exposed to sources of extraneous electricity which might result in premature detonation and serious injury.

5.2.1. NONEL. Nonel is a small diameter plastic laminate shock tube coated with a very thin layer of reactive material. It burns at approximately 6500 feet per second. A nonelectric detonation cord initiator is used to initiate the shock tube. This shock wave will propagate through most sharp bends, knots and kinks in the tube. The detonation is sustained by such a small quantity of reactive material, the outer surface of the tube remains intact during and after functioning. NONEL shock tube cannot be initiated by high frequency radio transmissions, static or stray electrical

rubber or plastic plug. The plug, securely crimped in the open end of the cap shell, forms a water-resistant closure and firmly positions the leg-wire ends inside the cap shell. The ends of the leg wires are joined together inside the cap by a short length of high-resistant wire called the "bridge wire", which is embedded in the cap's ignition mixture. When sufficient electrical current passes through the system, the bridge wire becomes hot enough to ignite the ignition mixture. In instantaneous electric blasting caps the ignition mixture causes the primer charge to detonate, subsequently detonating a high-explosive base charge. In a delay electric blasting cap the ignition mixture initiates the delay powder train which burns a predetermined time before igniting the cap's primer charge. The burning rate of the delay powder and the length of its column determine the time interval between application of the adequate electrical energy and the detonation of the cap. Blasting caps are available in both instant and delays with delay periods from a few milliseconds to more than 15 seconds. The use of delay blasting will improve rock fragmentation and displacement, provide greater control of vibration, noise and fly rock, reduce the powder factor and reduce blasting cost.

CAUTION: Electric blasting caps of different manufactures should not be used in the same series. Their ignition systems may not be electrically compatible and misfires may occur resulting in serious injury.

5.2.3. Nonelectric Blasting Caps. Nonelectric blasting caps, sometimes called fuse caps or ordinary blasting caps, provide a nonelectric method of initiating explosive charges when properly used in conjunction with safety fuse. The safety fuse conveys a flame at a relatively uniform rate to the blasting cap where it ignites the ignition charge. The Nonelectric blasting cap consists of an aluminum or copper shell approximately 1 3/8 to 1 3/4 inches long, loaded with three charges (fig 7):

- A base charge of High-velocity explosive in the bottom of the shell.
- A primer charge in the middle.
- A charge of ignition powder on the top.

The ignition powder insures flame pick-up from the safety fuse, the primer charge converts the burning into detonation and ignites the high explosive base charge. The NCF uses #6 and #8 Nonelectric blasting caps.

CAUTION: Since the ignition powder is exposed in the open end of the shell, Nonelectric blasting caps should not be tampered with or abused in anyway. Such treatment can lead to premature detonation resulting in serious injury.

5.2.4. Safety Fuse. The safety fuse is used in general demolitions. The safety fuse consists of ammonium nitrate black powder tightly wrapped with several layers of fiber and waterproofing material. It may be any color, but orange is the most common. The burning rate may vary for the same or different rolls from 30 to 45 seconds per foot under different atmospheric and climatic conditions. The burning rate should not be less than 30 seconds per foot. A fuse burns appreciably faster when it is confined by tamping or some other means of confinement; the greater the confinement, the faster the burning rate. Conversely, a fuse burns more slowly when it is subject to reduced external pressure. Other factors being equal, a fuse

will burn about 2 seconds per foot slower at an altitude of 5000 feet than at sea level. Although a burning rate of approximately 120 seconds-per-yard as measured unconfined at sea level is considered standard for commercial safety fuse in the United States, fuses with different burning rates are manufactured. *Do not depend on all fuse burning at 120 seconds-per-yard.* Testing each roll prior to using in the area where the charge is to be placed is required. Make sure to cut and discard a 6 inch length from the free end of the fuse to prevent a misfire caused by the exposed powder absorbing moisture from the air. Then cut off a minimum 6 foot length of fuse to check the most accurate burning rate. Take particular precautions if used underwater, as the rate of burning is increased significantly. Test each roll underwater before preparing the charge. It is important to know that the fuse burns at the core and not with its cover. However the cover may burn without the ignition of the core. When properly ignited, the core ignites with a jet of flame called the "ignition spit." This is a jet of flame that shoots out the end of the fuse the moment the powder core is lighted. This spit shows the core is lighted. **PRACTICE UNTIL YOU KNOW THE IGNITION SPIT.** Persons who do not recognize the ignition spit or who are misled by the burning of the cover have been killed or injured by trying to relight the fuse which has been ignited.

5.2.5. M60 Weatherproof Fuse Igniter. The M60 device is designed to ignite a safety fuse in all sorts of weather conditions, even underwater if properly waterproofed. The fuse is inserted through a sealing rubber grommet and into a split collet which secures the fuse when the end cap on the igniter is tightened. A pull on the pull ring releases the striker assembly, allowing the firing pin to drive against the primer, which ignites the fuse (fig 8).

5.2.6. MS-Connectors. MS connectors are Nonelectric short interval, millisecond delay devices for use on delaying blasts which are surface initiated by det cord. MS connectors are made of a molded plastic sleeve, that contains a copper tube delay element in the center portion. Each end of the sleeve is made so the det cord can be looped and locked in the connector with a tapered pin. They are color coded for different time intervals:

- MS-9 (9 milliseconds) blue.

- MS-17 (17 milliseconds) green.
- MS 25 (25 milliseconds) yellow.
- MS 35 (35 milliseconds) red.
- MS 42 (42 milliseconds)
- MS 50 (50 milliseconds)
- MS 65 (65 milliseconds)
- MS 100 (100 milliseconds)

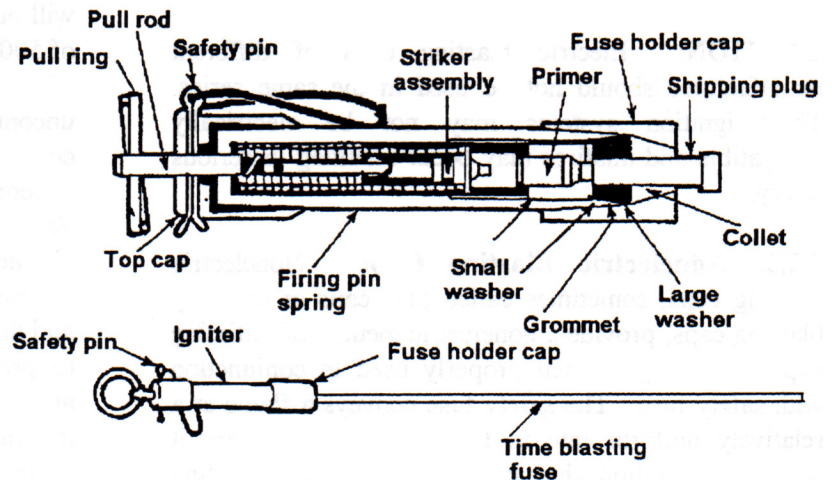

M60 weatherproof fuse igniter.

Figure 8

IMPORTANT:

READY-TO-FIRE LIGHTS AND/OR VOLTAGE METERS INDICATE FULL VOLTAGE ACROSS THE CAPACITORS. HOWEVER, THESE DO NOT PROVIDE A CAPACITOR CHECK AND, THEREFORE, DO NOT INSURE THAT THE MACHINE WILL DELIVER ITS RATED ENERGY OUTPUT. FREQUENT TESTING IS RECOMMENDED TO INSURE THAT THE MACHINE DELIVERS FULL ENERGY OUTPUT. SUCH TESTING CAN BE MADE BY A QUALIFIED ELECTRICIAN.

MS connectors are connected into the trunk line by cutting the trunkline at the desired location and bending the cut end of the cord into a 'U' shape. This loop is inserted into either end of the connector, making certain the cord contacts the metal tube, and pressing the tapered pin through the hole in the connector to secure the cord and to keep it in contact with the metal tube. The other end of the cut trunk line is put into the other end of the connector by repeating the same procedure.

Caution: Protect MS connectors from flame, excessive heat sparks, and accidental impact such as falling rocks or other heavy objects.

5.3. BLASTING EQUIPMENT AND ACCESSORIES. The blasting equipment used to test and

fire the blast is an important part of any blasting operation and should be of excellent quality. This equipment must be maintained in top condition at all times. Never attempt to use a blasting machine or test instrument that is not in proper operating condition. All electric blasting equipment must be checked for proper operation prior to use.

5.3.1. Capacitor Discharge Blasting Machines.

These machines have a capacitor, or bank of capacitors, that stores a large quantity of electrical energy supplied by dry cell batteries. The blaster can discharge the stored energy in the capacitors into the blasting circuit in a fraction of a second through the two terminal posts by pushing down a "firing" switch. Capacitor discharge (CD) blasting machines can fire many electric blasting caps in relation to their weight and size and are the most reliable firing means available.

5.3.2. Push-Down Blasting Machine. The Du-Pont No.50 Blasting Machine is a push-down blasting machine which is designed to fire 50, 30-foot copper wire electric blasting caps in straight series. The No 50 machine can be used to fire more caps provided they are connected in series-in-parallel. Under the most favorable conditions this machine can fire a total of 200, 30-foot copper wire electric blasting caps, connected in five series of 40 caps-per-series wired in parallel.

To operate the push-down blasting machine, it should be set squarely on a solid, level place, and the lead wires should be connected to the terminals. The blaster should position the machine with the terminals on the opposite side of the machine away from the operator. The handle (rack bar) should be lifted with both hands to its full extent and pushed down with a quick, hard strike to the bottom of the box. There should be no fear of damaging the machine by pushing the rack bar down too hard, because only in this

the rack bar down too hard, because only in this manner will the machine develop its full energy. Prior to hooking up lead wires this machine should be warmed up. This can be done by pushing the handle down as in normal use.

5.3.3. No. 10 Twist Blasting Machine. This machine is designed to fire a maximum of 10, 30-foot copper wire, instantaneous electric blasting caps in a series. Housed in a metal case, a special gasket provides a watertight seal between the cover and the case. This machine is used by blasters who never fire more than 10 caps in straight series. This machine should also be warmed up by a few twists of the handle prior to hooking up lead wires.

5.3.4. DuPont SS-240. This machine is manufactured by the ETI Corporation. The outside case construction is of heavy duty nonconductive polyurethane with fully encapsulated solid state circuitry. It is a 330 volt, 17.4 joule unit with the capability of firing 240 two ohm electric blasting caps in six series of 40 caps each connected in parallel to a 3.0 ohm lead line. The power source is four 1.5 volt "C" alkaline batteries.

5.3.5. Rheostat. This instrument will test the efficiency of a generator-type blasting machine. It can also be used to test capacitor discharge (CD) machines. The rheostat consists of a series of coils of varying resistance, each labeled in ohms and in terms of an equivalent number of 30-foot copper wire electric blasting caps. To test the output of a generator machine, a few electric blasting caps (and the equivalent resistance of several caps in the rheostat) are wired in series and energized by blasting machines being tested. Be certain the caps are positioned so that injury cannot occur from shrapnel or flying debris. If all the electric blasting caps fire, the machine's output is sufficient to fire a series of electric blasting caps with the same resistance.

5.3.6. Blasting Galvanometer. The Blasting Galvanometer can measure the resistance in ohms of the blasting circuit:

- to determine if the bridge wires of individual electric blasting caps are intact.

- to determine the continuity of an electric blasting cap series circuit.

- to locate broken wires and connections in a circuit.

To measure resistance with this compact instrument, place each of the two wires from the open end of the circuit on the two contact posts that extend out of the top of the galvanometer. The meter's top scale approximates the circuit's resistance (number of ohms), and the larger numbers on the bottom scale are only reference points and do not relate to the actual number of ohms in the circuit.

Only special silver chloride batteries must be used to power the Blasting Galvanometer. The galvanometer has an adjustment screw on the back of the instrument that can be used to zero the needle when a conductor is placed across the two contact points. The silver chloride cell has become weak, and should be replaced, when the instrument cannot be adjusted to a zero-ohm reading of the top scale and a 25-ohm reading on the bottom scale. The instrument will be checked for proper operation prior to each use. When the cell is exhausted, it must be replaced with the same type of silver chloride cell. Never change batteries in the vicinity of electric blasting caps. Never allow the silver chloride cell, or any battery, to come in direct contact with electric blasting caps. **DO NOT SUBSTITUTE ANY OTHER BATTERY FOR THE SILVER CHLORIDE.**

- Battery BA-245/6 0.9 volt FSN-6135-128-1632 for temperatures above 0 degrees F.

- Battery BA-2245/6 0.9 volt FSN 6135-833-9909 for temperatures below 0 degrees F.

5.3.7. Blaster's Multimeter. The DuPont Blaster's Multimeter, Model 101, is a compact volt-ohm-millivolt meter specifically designed to measure resistance, voltage, and current in electric blasting operations. Blasters must use only the recommended batteries in these machines. Other batteries will produce a hazardous current level. Never test an electric blasting cap or blasting circuit directly with a battery, recommended or otherwise, and never allow any battery to come in direct contact with electric blasting caps. This versatile meter can be used to:

- Measure the resistances of a single blasting circuit for continuity and the total resistance in a series-

in-parallel circuit with a high degree of precision and accuracy.

- Survey blast sites to determine if extraneous current hazards exist.

- Measure a wide range of resistances necessary to investigate static electricity hazards such as those possible in pneumatic loading operations.

- Measure power line voltages up to 600 volts AC and DC.

5.3.8. Cap Crimper. The cap crimper is used to squeeze the shell of a Nonelectric blasting cap around a safety fuse securely enough to keep it from being pulled off but not tightly enough to interfere with the burning of the powder train in the fuse. A stop on the handle limits the closing of the jaws to prevent this. The crimper forms a water-resistant groove completely around the blasting cap. Apply a sealing compound to

the crimped end of the blasting cap for use underwater. The rear portion of each jaw is shaped and sharpened for cutting fuses and detonating cords. One leg of the handle is pointed to be used in punching cap wells in explosive materials for easy insertion of blasting caps. The other leg has a screwdriver end. Cap crimpers are made of a soft nonsparking metal, which will not conduct electricity, and must not be used as pliers because such use damages the crimping surface. Although there are numerous manufacturers of crimpers, the description described above is that of the Dupont #4 crimper and most commonly found or reproduced. Blasters should visually check the type of crimper for proper operation.

5.3.9. Tamping Stick. A 1 inch diameter wooden tamping stick slightly longer than the deepest hole aids in loading. No metal parts are permitted in the stick, with the exception of a nonferrous metal coupling to join sections together. The stick must be inspected carefully before using to insure that no small rock chips are clinging to the end that touches the explosive.

CHAPTER 6

BLASTING

6.0. PURPOSE AND SCOPE. This section will discuss blaster certification, types of explosive, initiating devices, primers, loading techniques, loading logs, and safety. The Quarry Blaster course conducted by NCTC Port Hueneme awards NEC 5708, which must be revalidated annually for active duty personnel and biannually for reserve personnel. Although this is a qualification course, graduates cannot handle explosives without certification by the Commanding Officer of the operational unit. RNCF personnel who are employed as quarry blasters, on a full time basis, may be qualified for explosive duties, provided the following criteria are met:

- Notarized verification of employment, signed by employer.
- Successful completion of the requalification course.

Certification is the Commanding Officer's responsibility, and must be accomplished in accordance with OPNAVINST 8023.2 Series.

6.1. PRIMER MAKE-UP. Although there are several methods of priming cartridge "WG explosives" or dynamite explosives with cap and safety fuse, the safest and most common priming method is the reverse-end priming method. To use it:

a. Punch a hole, near the center, in the end and along the long axis of the high-explosive cartridge, sufficiently large to allow easy insertion, and deep enough to completely imbed the fuse cap into the explosive at least 2 1/2 inches. Never roll the cartridge to soften the end for easy insertion of the cap. This will greatly reduce the water resistance of the explosive.

b. Insert the cap such that at least 1/2 inch of explosive surrounds it in all directions. Never slit the

primer cartridge because this decreases the protection for the cap.

c. Fold the fuse back over the end so that it is not kinked and lies alongside the cartridge when the primer is loaded into the hole. Always use a wooden pole or a jointed wooden pole with non-ferrous connectors for loading. Never tamp the primer cartridge.

6.1.1. Primer Assembly with Detonating Cord. Fifty grain-per-foot and larger detonating cord will generally initiate a cartridge cap-sensitive explosive if it is placed inside the cartridge or in contact with it along the outside. There are exceptions to this, therefore, the priming recommendations for a particular grade of explosive should always be followed. For assurance, the detonating cord should be threaded through the 1 3/4 inch and larger diameter cartridges at least three cartridge diameters away from the priming end of the cartridge.

6.1.2. Primer Assembly with Cap and Fuse. Although the NCF no longer primes holes with caps, when making primers with nonelectric caps and safety fuse, there are three very important considerations:

- The fuse must not be kinked.
- The fuse should be positioned so that the loading pole will not damage it during loading.
- The blasting cap should be imbedded in the center of the primer cartridge along the longitudinal axis. In the more commonly used method called "reverse end-priming", an axial hole is punched in the end of the primer cartridge so that the blasting cap can be easily and completely inserted. Once the cap is in place, the fuse is then simply folded back over the end

so that it lies alongside the cartridge when the primer is placed in the borehole.

BURNING RATES. Before using safety fuse, the user must test a length of fuse not less than 6 feet. A burning rate of approximately 120 seconds-per-yard, as measured unconfined at sea level, is considered standard for safety fuse in the United States. Fuses with different burning rates are manufactured. Do not depend on all fuse burning at 120 seconds-per-yard. Manufacturers state that care and precaution are used to manufacture a safety fuse which will burn within an allowable variation of 10 percent either way from the standard. Manufacturers make no warranty or representations regarding the burning speed of their product because of the many circumstances and conditions the fuse is subjected to after leaving the factory. These include differences in altitude, weather, storage conditions, character of tamping, and mishandling, all of which affect the burning rate of the fuse.

NONELECTRIC CAP AND SAFETY FUSE ASSEMBLY. The following procedures should be undertaken when using nonelectric cap and safety fuse:

- Before uncoiling fuse be sure it is warm and flexible. A minimum temperature of 45 degrees is desirable.

- With each new roll of Safety fuse and when fuse has been exposed to the air for a considerable time, the ends must be cut off, a minimum of six inches, and disposed of.

- When measuring lengths the fuse should not be wound around small diameter nails or pegs since these sharp bends are very likely to cause a break in the waterproofing coat.

- The length of fuse cut should be sufficient to reach from the primer in the borehole to the collar, plus some additional length outside the hole. Make sure every fuse is initially cut to the same length. Short fuse or unequal lengths of fuse are not allowed. In all blasting of this type the approximate burning speed of the fuse should be known, and the minimum length should be planned to allow the blaster sufficient time to reach a place of safety after lighting the fuse. Under no circumstances can lengths of less than six feet of fuse be used. The burning speed of the fuse must be

determined by burning a section of fuse no shorter than six feet, and determining the burning time from ignition spit to end spit.

- The fuse cutter should have a clean, sharp blade to avoid smearing the waterproofing material over the powder train. Such smearing could result in misfires.

- Fuse should be cut squarely and inserted in the cap immediately after cutting. Slanting cuts should be avoided because of the possibility of tapered ends folding over and blocking the end spit when inserted in the cap. Also, a slanting cut prevents seating the fuse properly against the charge in the cap. Shears or scissors of any sort are poor fuse cutters because they tend to squeeze or crush the fuse.

- Fuse should not be handled roughly at any time either before or after cutting. Many misfires have resulted from the loss of powder at the end of the fuse before it was inserted in the cap. In some cases this was caused by slapping the end of the fuse roughly on the cutting bench or by shaking the fuse after it had been cut.

- Blasting caps should not be removed from the box until they are to be used. They should always be crimped tight enough to hold the cap securely in place and provide a watertight seal. A loose crimp permits the fuse to pull away from the cap charge or out of the cap entirely, and may allow water to get into the ignition shot. All crimps must be made near the open end of the cap shell, not more than 3/8 of an inch from the open end of the shell. Crimping more than 3/8 of an inch from the open end of the shell or other abuse of the explosive charges can prematurely initiate the cap.

- Safety fuse must be inserted into the cap until it touches the bottom. If it is not in contact, it may misfire. Do not force or twist the fuse or otherwise cause friction between the end of the fuse and the explosive in the cap, since this could detonate the cap. Place the index finger over the end of the cap to hold the cap on the fuse (fig 9). Position the end notch of the crimpers over the cap, approximately 1/8 inch to 1/4 inch from the open end. Move both hands down beside either leg, hold cap to fuse, remove finger and squeeze crimpers to the stop, open crimpers and remove from the cap (fig 10).

When blasting cap is to be used in underwater firing assemblies, a second crimp should be made approximately 1/8 inch from the first crimp toward the base (closed) end. Prior to the recrimping, rotate cap approximately 90 degrees.

CAUTION: DO NOT TOUCH THE END OF FRESHLY CUT SAFETY FUSE WITH MOIST FINGERS OR OTHER DAMP OBJECTS. DAMPENING THE FUSE END CAN CAUSE A MISFIRE.

WARNING: DO NOT FORCE SAFETY FUSE INTO A BLASTING CAP. IF IT DOES NOT ENTER EASILY, REJECT THE CAP AND / OR FUSE.

WARNING: DO NOT CRIMP THE CAP WITH TEETH OR KNIFE; CRIMP WITH CAP CRIMPER.

6.1.3. Primer Assembly with Electric Blasting Cap.

(ANY USE OF ELECTRIC BLASTING CAPS REQUIRES NAVFAC APPROVAL) The preferred method for priming cap-sensitive cartridges with an electric blasting cap is to punch a hole in one end of the cartridge and insert the cap deep into the explosive so that it lies as close as possible along the long axis of the cartridge. The blasting cap wires are then secured to the cartridge by making the cap wires into two half hitches around the cartridge. Two half hitches are preferred but a single half hitch is generally adequate in diameters 1 to 1 1/2 inches and smaller.

6.2 BLASTING WITH DETONATING CORD.

Detonating cord is relatively insensitive and requires a proper detonator, such as a No.6 strength cap, for initiation. Despite this low sensitivity, PETN detonates at a velocity of about 22,000 feet-per-second. As such, detonating cords are safe and reliable non-electric detonating devices.

6.2.1. Ability to Initiate Other Explosives. The ability of detonating cord to initiate other explosives depends in part on the density of the PETN core or the grains of PETN per linear foot of cord. The most widely used cords have approximately 25 to 60 grains-per-foot. Make certain in all cases that the detonating cord is sufficient strength to initiate the booster or

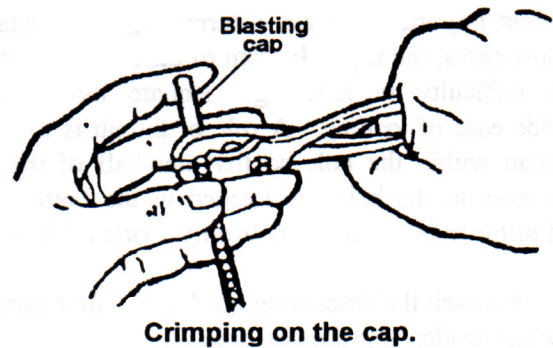

Figure 9

explosive charge.

6.2.2. Nonelectric Blasting Systems. Detonating cords are particularly well suited for operations where a nonelectric blasting system is preferred because potentially hazardous stray currents may be present.



Holding the fuse while crimping.

Figure 10

6.2.3. Priming and Loading. In most blasting situations 50 grain-per-foot detonating cord is preferred as the downline to initiate the high explosives column charge or primers. It has a greater priming reliability and tensile strength than the lower load detonating cord and a greater economy than larger detonating cords. On the other hand, 25 grain-per-foot detonating cord is widely used in shallow holes such as those found in pipeline work and in trunkline layouts. Large diameter boreholes are often initiated with detonating cord for reasons of safety, prevention of cutoffs and multiple-point priming. Some of the basic procedures in loading a large diameter borehole with 50-grain detonating cord are:

LOADING TECHNIQUES. Exercise great care in loading boreholes for firing. Before starting to load, all dirt and rock chips must be removed from the borehole and cleaned away from the mouth of the hole. Loose dirt and rocks may produce a spark and cause a premature explosion. Check the borehole with a mirror or tape to make sure it is clear of obstruction and to full depth. Dirt and rock chips are removed from the borehole by blowing them out with compressed air.

The placement of explosives in the borehole is one of the most important factors determining fragmentation. In most cases, the toe or bottom of the hole presents the most difficulty in assuring adequate movement to provide ease of loading. A rule of thumb is to design the load within the hole so that one-half of the total explosives in the hole are located in the bottom one-third of the hole depth. *This is only a rule of thumb.*

- Attach the detonating cord to the first cartridge or primer loaded into the borehole.

- Insert a rod or spindle through the axial hole of the detonating cord spool to facilitate handling. This rod can be held in the hand or mounted in the top of a box. This allows the detonating cord to run off the spool while the cartridge or primer is being lowered (not dropped) to the bottom of the hole.

TAMPING. Correct depth of the hole should be checked before loading. The cartridge is inserted in the hole and the tamping stick is used to guide the cartridge down until it is in place. The charge is then pressed to assure good contact. Succeeding sticks should be pressed to assure good contact. To prevent air spaces caused by punching holes in cartridges, the end of the tamping stick should be cut square. If a cartridge sticks in a borehole, it should not be forced down. If firm steady pressure on the tamping stick does not dislodge it, another prime charge should be placed on top of it.

CAUTION: WHEN LOADING OR TAMPING, DO NOT BEND FORWARD; KEEP THE HEAD AND BODY BACK AND AWAY FROM THE BORE-HOLE.

THE FIRST CARTRIDGE. After the first cartridge is loaded, cut the detonating cord from the spool. It is most important to move the reel to the next borehole, or to a safe distance, as soon as the detonating cord extending from the hole has been cut. If the reel is left connected to the hole, it may detonate on the surface in the event of a premature firing. This could propagate to other explosives piled near the hole with disastrous results.

- Allow three feet or more of extra detonation cord to compensate for any slumping of the first cartridge deeper into the hole and for making later surface connections.

- Draw the detonating cord line taut and hold it at one side of the hole so that it is not broken by and does not interfere with the subsequent loading operation.

- After loading the borehole, fasten the end of the cord at the top of the hole by tying it around a rock or some other object heavy enough to prevent it from being kicked or pulled by the product slumping into the borehole. The detonating cord should be secured with sufficient slack to allow some movement for this slumping.

SLITTING THE CARTRIDGE. For best results, dynamite cartridges, except for the primed cartridge, must be expanded to fill the entire diameter of the hole. To make packing and tamping easier, a lengthwise slit should be cut with a knife in the paper cover on the cartridge before loading.

COLUMN LOADING. In column loading, the charge is placed evenly throughout the lower portion of the borehole up to the calculated heights. The top portion is filled with stemming, preferably drill cutting.

DECK LOADING.—Deck loading or intermittent loading is the placing of several charges in the borehole separated from each other by stemming (fig 11). This method is used when

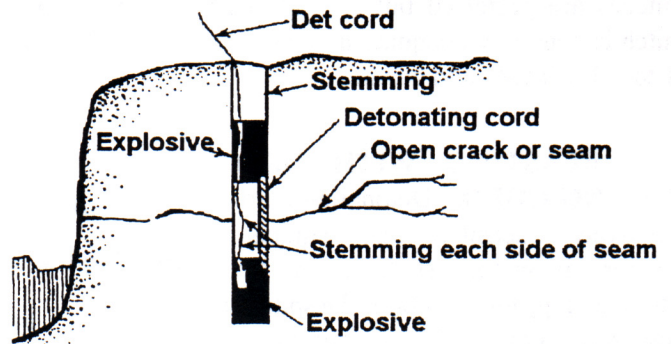

1. Bypassing crack or seam.

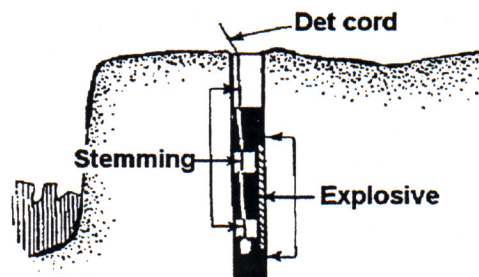

2. Spacing out small charge.

Deck loading.

the borehole passed through a seam or a crack in the rock, and the force of the blast might blow out through the crack. A charge is placed below and above the crack with stemming tamped between the charges. This method is also used to distribute the charge in a borehole of large diameter or of extreme depth to increase shattering and to reduce secondary blasting. Deck loading may be used when the only available explosive is too strong for the type of rock to be blasted. In deck loading, each charge must be separately primed regardless of the type of detonating primer used. Detonating cord is normally used and all decks are connected by a single line. Where there is a possibility that the cord may be damaged or that loading is going to be difficult, a second line should be placed on the opposite side of the first to prevent a misfire.

STEMMING.—All boreholes are filled from the top of the explosive to the mouth of the hole with stemming (fig 12). The closeness with which the explosives column is loaded to the collar of the hole with stemming material is a major factor controlling fly rock. It would be dangerous to offer any generalization for controlling stemming height. The stemming height should be based on thorough knowledge of the formation, the explosive ratio being used, and the amount of fly rock that can be tolerated, tempered with judgment and experience. When quarry blasting, the minimum stemming allowed within the NCF is 6 feet.

When the stemming is being loaded, the same care and attention should be exercised as in loading the explosives. Care must be taken to avoid damage to the detonating cord. The potential for damage to the initiating system during any attempt to compact the stemming is too great to justify the slight advantage that might be achieved by compaction.

Drill cuttings make the best stemming material, and next is fine moist sand free from rock chips. However if the borehole is holding water, sand would cause a slurry and a possible blowout. In this case 3/8" minus should then be used.

6.2.4. Knots, Connections, and Layouts. Detonating cord is easy to connect for a blast. Most detonating cords detonate between sections spliced or joined together securely and tightly with the proper knots. The following recommendations apply for most cords which have core loads of 20 to 60 grains of PETN

per foot. In general when connecting sections of detonating cord together:

- Make sure the cut ends are free of water, oil, or other contaminants. Cut ends of cord pick up moisture through a capillary action, but this penetration is generally less than eight to 12 inches. Place all connections or detonators at least 12 inches from the exposed open end to be sure of positive initiation. This includes all knots, MS connector connections, and cap attachment points. If initiated by a cap from a dry end, straight (unknotted) lengths of detonating cord will continue to detonate even through a wet core. If loaded holes have been exposed to moisture for some time, such as a week or more; or if there is any chance that the end of the downline may have become wet, end priming, or a high-velocity booster such as "Detaprime" WG, should be used at the connection. Lower velocity explosives are not suitable for this purpose.

- Make sure all connections are at right angles. Avoid sharp angles, which can cause the cord to cut

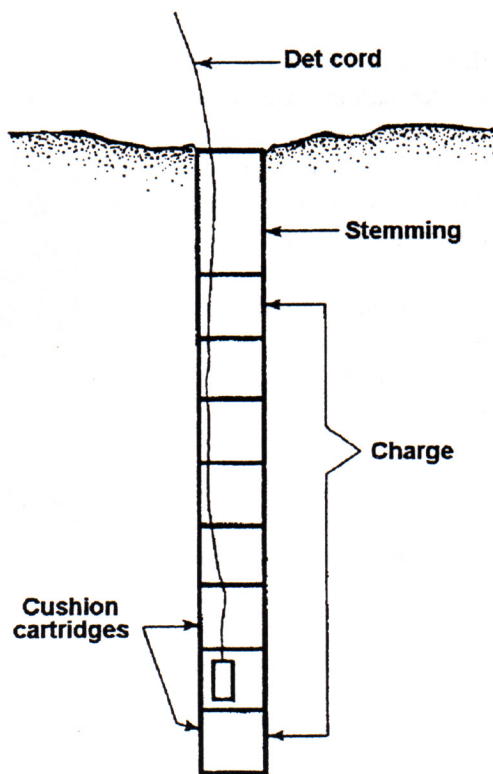

Placing primers in holes.

Figure 12

itself off. Angle cutoff failures are caused when

detonating cord branchlines or downlines slant back at an acute angle toward the main detonating cord trunkline. The explosive forces, or fragments and missiles from the detonation of the main trunkline, sometimes sever the branchline or downline before the detonation wave reaches it through the knotted connection.

- Do not kink, bend, scrape, or leave slack in the detonating cord trunklines or borehole downlines or uplines.

- Make sure all detonating cord knots are tight and in contact so they cannot work loose. Loose knots may fail to transmit the detonation wave. Avoid knots in the borehole. But if knots are necessary, tie a square knot with at least 12 inches of extra cord at the free ends and tape these ends with electrician's tape. These knots should be located in or next to a cap-sensitive explosive.

- Make sure every borehole has two paths by which the detonation can reach it and cross-ties between the trunklines at regular intervals frequent enough to provide positive detonation of the trunkline. Cross-ties should be placed more frequently when the spacing and burden are small. These cross-ties are insurance against trunkline cutoffs due to ground movement or flying debris from the holes which fire earlier in the shot's sequence.

- Always cut off the excess cord after tying in to prevent the excess from detonating across the trunkline and cutting it off.

- Always keep the shot pattern as clear as possible of boxes, box liners, explosives, etc., so that the trunkline layout is readily visible, distinctive, and neat.

- When several detonating cord down-lines, uplines, or trunklines are used, make sure they do not cross over each other. One cord may detonate prior to

the other cord severing it and causing it to fail. This can be prevented by taking the slack out of all detonating cord lines, by holding detonating cord lines on opposite sides of the borehole during loading, and by never crossing over other lines in surface connections.

6.2.5. Types of Knots and Splices. Detonating cords should be spliced together with a conventional square knot. Splices are not recommended in the downlines or uplines inside the borehole since failures can result from:

- the breaking or damaging of the splice during the loading or stemming operation of the load.

- the penetrating of water through exposed cord ends or cracks in its covering at the knot. Where it is absolutely necessary to use splices in the

borehole, the splice knots should be taped to prevent oil or water penetration.

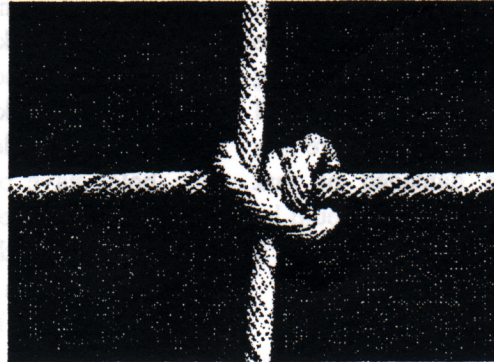

A reinforced trunkline is connected to downline with double-wrap half-hitch.

Figure 13

RIGHT ANGLE CONNECTIONS.—The usual connections between; downlines or uplines and a detonating cord trunkline, cross-ties between trunklines, or other right-angle hook-ups should be made with a double-wrap half hitch, (fig. 13) or by clove hitching the trunkline over a loop in the down-line (instead of the single cord) and by tucking the loose end through the loop at the top (fig. 14).

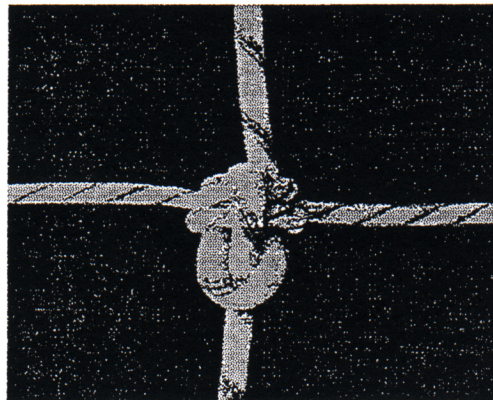

Special clove hitched trunkline prevents slippage from subsidence.

Figure 14

6.2.6. Shot Patterns. For many years all detonating cord blasts were fired instantaneously with a detonating cord trunkline and, in a few cases, with regular electric caps attached to the downline in each hole. Now, however, most blasts using detonating cord are delayed either on the surface or in the borehole with fast delay techniques. These methods retain virtually all the safety advantages of conventional trunkline firing, especially when using MS connectors.

Nevertheless, it must be realized that delay

initiation on surface by any method tends to be more vulnerable to failures or partial failures from ground movement than from the use of instantaneous methods or bottom hole delays. The difficulty with surface delays can be minimized by use of proper drill and delay patterns. There are several ways to surface delay a blast with detonating cord, popular methods are:

- The use of MS connectors in the detonating cord trunkline.

- the use of MS delay electric or non-electric blasting caps attached to the detonating cord downline.

6.2.7. Instantaneous Firing. Very few detonating cord blasts today are not delayed, although some operators still fire them instantaneously where no vibration and air blast problems exist. Probably the biggest incentive to fire a blast instantaneously is in a shooting situation where the possibility of cutoffs in the powder column from shifting ground outweighs the improvement in fragmentation gained by using delays. However, there are very few geological formations which are not adaptable to delay blasting. Even when no delays are used, it is important to design the blast so that the detonating cord fires the bore-holes in proper sequence with respect to the open face or toward the direction in which blasted rock should move. The biggest consideration is to design the initiation pattern so that boreholes near the free face are initiated first and do not cut off later firing holes by ground movement. Some slight improvement in rock breakage, fragmentation, displacement, back break, and fly rock may be achieved by firing the holes nearest the free face. The delay time achieved by the detonation rate of the cord is approximately one millisecond per 22 feet. Therefore the delay effect will be minimal.

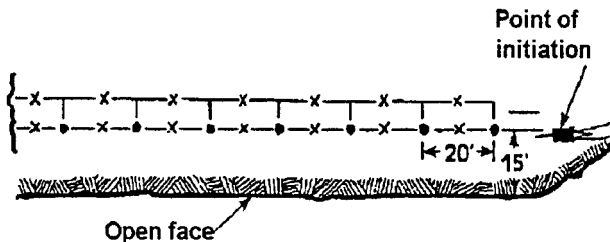

Single row shot fired in sequence MS connectors inserted at points "X".

Figure 15

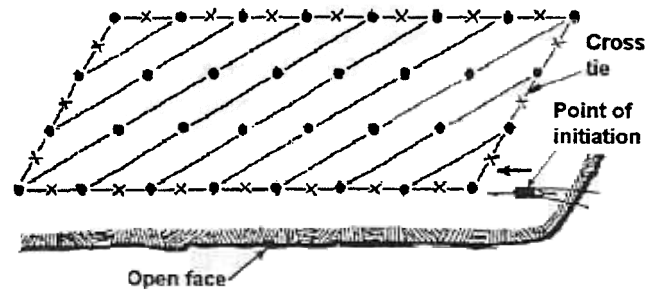

Multiple row shot with the holes and rows fired in sequence from one end.

Figure 16

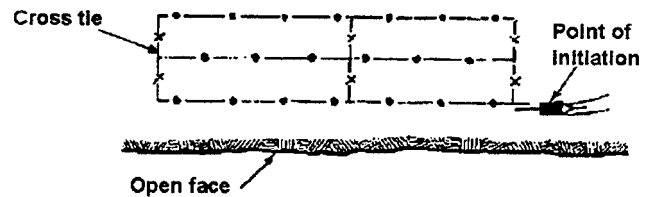

A multiple row shot which is to be initiated in echelon at the center front.

Figure 17

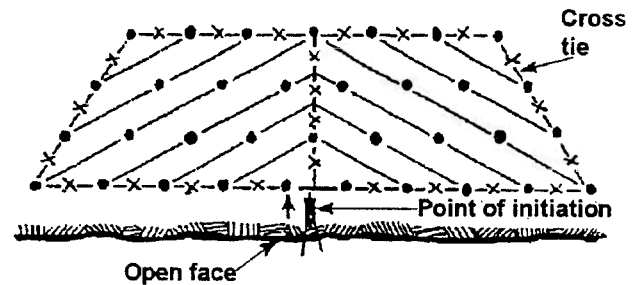

Another multiple row shot but here all rows are fired in sequence.

Figure 18

6.2.8. Surface Delay Systems. As a result of early experience with short interval delay firing and surface initiation, spacings under 15 feet were believed questionable without risking cutoffs. However, later developments indicated that borehole cutoffs depended more on the general blast layout and depth of holes and physical characteristics of the formation (such as pitch of strata, fracture planes, and seams) than on the borehole spacings and burdens. For example, today

MS connectors are successfully delaying from the surface small diameter holes in ditch blasts with spacings of three to four feet. However, it is generally accepted that the delay time between holes should not exceed one millisecond per foot of spacing.

MS connectors offer the most convenient means of firing detonating cord blasts by the short-interval delay method on the surface. They are simply coupled or tied into the trunkline between the boreholes or groups of boreholes to sequence the blast in a predetermined order. They are manufactured with delay intervals of 9, 17, 25, 35, 42, 50, 65, and 100 milliseconds. The shorter intervals are generally required for small diameter holes drilled on close spacings, while the longer intervals are for larger diameter holes drilled on wider spacings. To minimize cutoffs, a good rule of thumb is to allow at least one foot between holes for each milli-second of delay and to always locate MS connectors either mid-way between holes or closer to the hole being delayed. Consequently, the usual intervals are 9, and 17 milliseconds when the borehole patterns range from 7 to 25 feet or greater. Figures 15, 16, 17 and 18 show a few conventional layouts for single-row and multiple-row vertical hole blasts with MS connectors.

MS connectors can be desensitized, or their delay time can be lengthened, if they are exposed for a long period of time to water. This results in misfires. When wet conditions are encountered, the units must be protected from moisture. Every effort should be made to elevate the MS connector out of the water and to fire as soon as possible in order to reduce exposure time. Also the connectors should be protected from abusive shock, heat, impact, or friction as they have an impact sensitivity equivalent to blasting caps. Consequently, all unnecessary personnel and equipment should be removed from the shot area before the MS connectors are tied in.

6.2.9 Ditching. MS connectors are successfully used in pipeline construction work. In this application they can improve the fragmentation, reduce fly rock, cut down on overbreak, and help pull a smooth bottom on tough blasting jobs. Thus, they speed up backhoe production, reduce cleanup work, and minimize back shooting. When the bottom of the ditch is broken smooth and clean, the amount of padding necessary under the pipe is reduced (See fig. 19).

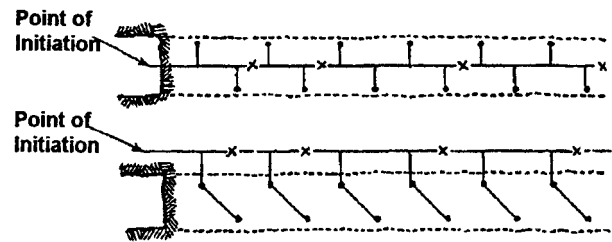

A ditch shot delayed with MS connectors (at "X") in groups of two and four holes with a trunkline inside the ditch (top) and trunkline outside ditch (bottom).

Figure 19

6.2.10. Igniting Det Cord.

FIRING TRUNKLINES.—Trunklines may be fired with cap and safety fuse, electric blasting caps, or NONEL. The NONEL system is preferred since it will permit optimum control of the instant of firing. When firing with electric blasting caps, two caps are attached side by side along the detonating cord with the charged ends pointing in the direction that the detonation will fire. They are securely fastened with friction tape insuring direct contact between the caps and the detonating cord. Figure 20 shows completed connections. Care should be taken to prevent the end of the detonating cord, where the caps are to be attached, from becoming wet. If they have become wet and cannot be cut back to a dry core, the cord should be detonated with a "Detaprime" WG booster.

MS DELAY ELECTRIC BLASTING CAPS.—Short-interval delay electric blasting caps have been widely used for firing detonating cord blasts. This technique was especially prevalent prior to the introduction of MS connectors. They are attached on the surface, either to the downline at the individual blast hole or to the trunklines connecting rows or

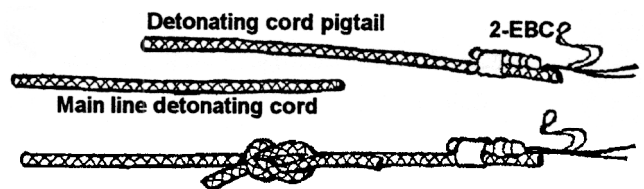

Recommended method for attaching detonating cord to the main line.

Figure 20

groups of holes. The method of attaching the caps is shown in figure 20. Remember the time interval between some periods of MS delay caps may be as long as 100 milliseconds, and they should be used only in conditions where this delay interval will not cause cutoff of the downline due to earth movement. With MS delay caps surface noise can be minimized because the use of a surface trunkline is eliminated. The system requires as much wiring as an electrical blast of equal size, and the usual precautions must be observed to prevent premature explosions from stray currents. However, the use of detonating cord tails for hooking up the individual holes minimizes the length of exposure time to such hazards.

DETONATING CORD TAIL.—As an added recommended precaution, the caps should first be attached to a detonating cord tail about 18 inches long (fig 20). This is placed in the approximate position several feet away from the main detonating cord while the electrical firing hookup is being made and other preparations are being completed. After all unnecessary personnel have been removed from the blast area and shortly before scheduled blast time, the detonating cord tail with attached blasting caps can be tied on the main trunkline by means of a square knot.

DETONATING CORD AND ANFO.—Detonating cords for initiating primers can sometimes cause low-order detonations of ANFO products in small-diameter holes (less than four inches). In single-point bottom priming the cord shoots through the ANFO column before reaching a primer and delivers a sharp blow to the ANFO. In some cases the energy of the cord is sufficient to partially detonate the ANFO. This results in a portion of the column's being partially detonated at a sub maximum or low-order rate. This is sometimes the reason for poor or inconsistent breakage from the upper portions of holes. This effect can be minimized by the use of multiple-point priming. Place one primer near the top of the ANFO column and another close to the bottom of the hole, but never more than 20 feet apart. In deep holes several primers spaced 10 to 15 feet apart may be necessary. Detonating cord and ANFO should not be used together in holes less than four inches in diameter.

6.3. BLASTING WITH NONELECTRIC CAP AND SAFETY FUSE.

6.3.1. Lighting The Safety Fuse. To hand light

safety fuse, an intensely hot flame must be used and the fuse ends must be clean and freshly cut. Fuse should never be lighted by a gasoline or kerosene torch, a burning stick of wood, a roll of paper, a cigar, or cigarette. No method of hand lighting should be used which obscures or conceals evidence that the fuse has been lighted. These methods are not only slow and undependable, but they are also extremely dangerous. The M60 Weatherproof Fuse Igniter is an approved method of lighting safety fuse.

POWDER CORE.—The powder core of safety fuse burns inside its wrapping and cannot be seen after the fire from the initial spit. Some brands emit smoke through the wrapping as the powder burns. Visual discoloration on the outside of the fuse is readily apparent, however, this may be some distance behind the point of the burning core. For this reason it is not a reliable indication of where the core is burning. The end spit is a jet of flame about two inches long that shoots out of the end of the fuse the moment it is lighted. It lasts at least a second and is followed by smoke which rises from the end of the fuse.

SAFETY TIME FUSE IGNITION.—An M60/ T2 fuse igniter shall be used to ignite the time fuse (fig 8).

HOT-WIRE FUSE LIGHTER.—This device is similar in appearance to a fireworks sparkler. It consists of a wire covered with an ignition composition that burns slowly and at a fairly steady rate with an intense heat. It is lighted by a match and can be used to ignite fuse merely by holding the burning portion of the lighter against the freshly cut end of fuse.

IGNITER CORD.—Igniter cord is a small cord which burns progressively along its length with a short, hot, external flame at the zone of burning. Igniter cord is available in three different burning speeds. Safety fuse can be ignited efficiently with igniter cord and igniter cord connectors. This system enables the blaster to fire multihole blasts in sequence with a single lighting and without cutting different length safety fuses. The safety fuse must be cut in equal lengths, and the desired timing will then be from the igniter cord rather than from the length of the fuse.

IGNITER CORD CONNECTORS.—Igniter cord connectors are metal shell, aluminum or brass devices for connecting the igniter cord to the safety fuse. These connectors are crimped to the precut lengths of safety

fuse on the free end not crimped to the blasting cap. They are designed to protect the end of the safety fuse from moisture and can be attached to the igniter cord with a minimum of effort. The connectors contain a small pressed charge of an ignition compound that lights the fuse when the igniter cord burns through the connector.

6.3.2. Safety Reminders While Using Safety Fuse and Nonelectric Blasting Caps.

- The fuse burns at the core and not at its cover. The cover may burn without the ignition of the core. When properly ignited, the core ignites with a jet of flame called the "ignition spit", this spit shows the core is lit. Practice ignition until you know the ignition spit. Persons who fail to recognize the ignition spit, or who are misled by the burning of the cover, have been killed or injured by trying to relight fuse which has been ignited.

- Have two persons present when lighting the fuse; one person to do the lighting; and the other to keep an accurate account of time and observe all conditions. In this way preventive action can be taken in the event there is an unforeseen change in conditions during the lighting operation.

- Be sure the explosives charge is in place before the fuse is lighted. Never hold the charge in your hand with the intent of throwing or relocating it, when lighting the fuse.

- If the charge does not detonate, or you do not hear the detonation at the calculated time, do not return to the blast area until a period of 30 minutes has elapsed. After which time only one blaster shall be permitted to return to investigate the misfire. When the area is determined to be safe, preparation for a second ignition may commence.

6.4. ELECTRIC FIRING TECHNIQUES.

Because of the possibility of Hazards of Electromagnetic Radiation to Ordnance (HERO) problems associated with electric blasting caps at the training and deployment sites, any blasting with electric blasting caps requires prior approval from COMNAVFACENGCOCOM (Code 123). The following techniques are being discussed in theory only.

6.4.1. Successful Electrical Blasting Depends on Four General Principles.

1. Proper selection and layout of the blasting circuit.

2. An adequate energy source compatible with the type of the blasting circuit selected.

3. Recognition and elimination of all electrical hazards.

4. Circuit balancing, good electrical connections, and completed circuit testing.

6.4.2. Circuit Selection.

The selection of the circuit will depend on the number of electric blasting caps to be fired and the type of operation. In general, a simple series circuit is used on small blasts consisting of less than 50 electric blasting caps. A series-in-parallel circuit is used where a large number of electric blasting caps is involved. The parallel circuit is used only in special applications which will be discussed later in this chapter. In almost every application capacitor discharge blasting machines offer the safest, most dependable, and economical source of electrical energy for blasting.

Elimination of electrical hazards must be the first consideration before starting to load any blast. Some causes of extraneous electricity are:

- Stray ground currents from poorly insulated and improperly grounded electrical equipment.

- Lightning and static electricity from electrical storms.

- High radio frequency energy near transmitters.

- Induced currents present in alternating electromagnetic fields, such as those commonly found near high-voltage transmission lines.

- Static electricity generated by wind driven dust and snow storms, by moving conveyor belts, and by the pneumatic conveying of ANFO.

- Galvanic currents generated by dissimilar metals touching or separated by a conductive material.

6.4.3. Electrical Misfires. Lack of attention to details is the most frequent cause of electrical misfires resulting in fatal or serious injury and costly property damage. The electrical connections must be tight, clean and insulated from the ground. Care must be taken to avoid abrading or stripping the leg wires either in the hole or on the surface. Lead lines should be inspected and tested prior to every blast.

The resistance of all circuits should be calculated, and a Blaster's Multimeter or Blasting Ohmmeter should be used to verify the calculations. No attempt should be made to fire the blast until the theoretical calculations and the test readings are the same. In brief, extreme care in wiring and testing the circuit is absolutely necessary to avoid misfires.

6.4.4. Safety Requirements. In any blasting operation the blasting machine, or blasting switch, must be directly under the control of the head blaster. It should be kept locked while not in use with the key in the blaster's possession.

The lead wires should be made of well insulated, solid core 10 to 14 gauge copper wire. They should never be laid out until the blast circuit is completely wired and all unnecessary personnel have been removed to a safe location. After the lead line is laid out, it should be checked electrically with a Blaster's Multimeter for continuity of circuit. It should also be visually inspected for cuts and serious abrasions in the insulation. The end of the lead line must be shunted before the other end of the line is connected to the blasting circuit. After the final connections are completed, the resistance of the entire circuit should be tested with a Blaster's Multimeter or a Blasting Ohmmeter. The calculated resistance of the entire circuit must always agree with the readings on the instrument or no attempt should be made to fire the blast. If proper readings are not obtained, reshunt the lead line before returning to the blast area to locate and correct the source of trouble. Do not allow the bare ends of the circuit or the lead line to come in contact with the ground

or with any metallic object.

When the instrument readings confirm the calculated resistance, the blasting machine, or blasting switch, can be unlocked and the lead lines can be connected for firing.

After the blast, the blasting machine, or blasting switch, should be locked before returning to the blast area. Never leave a blasting machine or blasting switch unguarded.

6.4.5. Current Requirements. Successful simultaneous initiation of a large number of electric blasting caps requires delivery of sufficient current to all caps within a few milliseconds. The time required to heat the bridge wire in an electric blasting cap to a temperature that will cause burning of the ignition charge is a function of the current intensity. The bridge wire in domestic commercial blasting caps is approximately 0.05 millimeters and requires 1.5 amperes for reliable initiation. The bridge wire heats up very quickly, but it rapidly transfers heat to the bridge posts and ignition mix. As a result, energy delivered over a time interval of more than 10 milliseconds is not as efficient in heating the bridge wire as the same amount of energy delivered in a few milliseconds.

The importance of delivering sufficient current to all caps in the circuit within a few milliseconds cannot be overemphasized. At marginal low current levels, slight differences from one cap to another can result in large variations in initiation times. In series circuits this can result in one cap's detonating prior to initiation of all the caps. This fast firing of the cap cuts off the flow of current before all caps have been initiated and results in failure of one or more caps.

The internal construction of electric blasting caps manufactured by different companies varies considerably. As a result, they are not compatible in the same blasting circuit. Therefore, electric blasting caps of different manufactures must never be used in the same blast. Such a practice is almost certain to result in dangerous misfires.

6.4.6. Testing Blasting Circuits. A Blaster's Multimeter, Blasting Ohmmeter or Galvanometer

can be used to test blasting circuits for continuity and resistance. "Never use any test instruments not specifically designed for blasting circuits. Before using an instrument, make certain the needle can be adjusted to "zero" when the terminals are shunted, if not, replace the batteries and make the necessary adjustments. Replace the battery with the same type of battery specified by the manufacturer for use in the blasting instrument. Do not change batteries in the presence of electric blasting caps.

To properly test the circuit, the theoretical resistance of the circuit must be calculated. Chart "D" gives the resistance of Du Pont electric blasting caps for copper and iron leg wire of various lengths. Chart "E" gives the resistance per 1,000 feet of wire for the various types of wire.

Chart D

Nominal Resistance of DuPont Electric Blasting Caps in Ohms per Cap*

Length of Wire Feet	Copper Wire		Iron Wire	
	Instantaneous Caps	Delay Caps	Instantaneous Caps	Delay Caps
1	1.26	1.16	2.10	2.00
6	1.34	1.24	2.59	2.49
7	-	-	2.84	-
8	1.42	1.32	3.09	2.99
9	-	-	3.34	-
10	1.50	1.40	3.59	3.49
12	1.58	1.48	4.09	3.99
14	1.67	1.57	4.58	4.48
16	1.75	1.65	5.08	4.98
20	1.91	1.81	6.08	5.98
24	2.07	1.97	-	-
30	2.31	2.21	-	-
40	2.15	2.06	-	-
50	2.42	2.32	-	-
60	2.69	2.59	-	-
80	2.71	2.61	-	-
100	3.11	3.01	-	-
120	3.51	3.41	-	-
150	4.11	4.01	-	-
200	5.12	5.02	-	-
250	6.12	6.02	-	-
300	7.13	7.03	-	-
400	9.13	9.06	-	-

*At 68° Fahrenheit

Chart E

Resistance of Copper Wire*

AWG Gauge No.	Ohms per 1,000 Ft.
6	0.395
8	0.628
10	0.999
12	1.588
14	2.525
16	4.020
18	6.390
20	10.150
22	16.140

*At 68° Fahrenheit

SERIES CIRCUIT.—The total resistance of a series circuit is equal to the resistance of each cap multiplied by the number of caps plus the resistance of the lead line and connecting wire.

Example 1: Assume a series circuit of 25 40-foot copper wire DuPont MS Delay Blasting Caps with a 600-foot 14-gauge copper lead line.

Step 1: Determine the resistance of the cap circuit.

Consult Chart "D" for the resistance of a 40-foot copper wire MS Delay. This is 2.06 Ohms/cap.

Resistance of Cap Circuit = No. of Caps x resistance/cap

$$R = 25 \times 2.06$$

$$R = 51.5 \text{ Ohms}$$

Step 2: Determine resistance of the lead line: Consult Chart E for the resistance of 14-gauge copper wire. This is 2.525 ohms/1000 feet. A lead line that is 600 feet long has 1200 feet of wire (600 feet x 2 conductors=1200 feet)

$$\text{Resistance of Lead Line} = \frac{\text{Len. of Wire} \times \frac{\text{Resistance}}{1000 \text{ ft.}}}{1000}$$

$$R = \frac{1200 \times 2.525}{1000}$$

$$R = 3.03 \text{ Ohms}$$

Step 3: Determine total resistance of the blasting circuit.

Total Resistance=Cap Circuit Resistance+
Lead Line Resistance

$$R=51.5+3.03$$

$$R=54.53 \text{ Ohms}$$

The needle on the instrument must be adjusted to "zero" when it is shorted between terminals. The terminals are then connected to the lead line. The instrument should then read approximately 54 to 55 ohms. Too low a reading indicates some caps are not connected into the circuit. Too high a reading indicates too many caps in the series or loose or dirty connections.

SERIES IN PARALLEL.—In a series in parallel circuit, each series should be electrically balanced with each series reading the same number of Ohms. Usually, an equal number of caps in each series will produce balanced series. In a balanced series in parallel circuit, the resistance of one series divided by the number of series will equal the total resistance of the circuit.

Example 2: Assume a blast of 300 50-foot copper wire MS Delay connected in six series with 50 caps-per-series and a 700-foot 14-gauge copper wire lead line.

Step 1: Determine the resistance of a single series. Resistance of one series=No. of Caps x Resistance per cap.

Consult Chart "D" for cap and wire resistance.

$$R=50 \times 2.32$$

$$R=116 \text{ Ohms}$$

Step 2: Determine the resistance as each series is connected to the lead line or bus wire:

$$\text{Resistance} = \frac{\text{Resistance}}{\text{Series}} \\ \text{Resistance} = \frac{\text{Series}}{\text{No. of Series}}$$

$$\text{One Series Resistance} = \frac{116.0}{1}$$

$$R = 116.0 \text{ Ohms}$$

$$\text{Two Series Resistance} = \frac{116.0}{2}$$

$$R = 58.0 \text{ Ohms}$$

$$\text{Three Series Resistance} = \frac{116.0}{3}$$

$$R = 38.7 \text{ Ohms}$$

$$\text{Four Series Resistance} = \frac{116.0}{4}$$

$$R = 29.0 \text{ Ohms}$$

$$\text{Five Series Resistance} = \frac{116.0}{5}$$

$$R = 23.2 \text{ Ohms}$$

$$\text{Six Series Resistance} = \frac{116.0}{6}$$

$$R = 19.3 \text{ Ohms}$$

Step 3: Determine resistance of the lead line: 700-foot lead line is 1400 feet of wire (Length of Wire=700 feet x 2 conductors =1400 Ft.).

$$\text{Resistance} = \frac{\text{Length of Wire} \times \frac{\text{Resistance}}{1000 \text{ Ft.}}}{1000}$$

$$R = \frac{1400 \times 2.525}{1000}$$

$$R = 3.535 \text{ Ohms}$$

Step 4: Determine total resistance of the blasting circuit:

$$R = \text{Cap Circuit Resistance} + \text{Lead line Resistance}$$

$$R = 19.3 + 3.535$$

$$R = 22.8 \text{ Ohms}$$

It becomes evident from the example that the meter readings decrease as each series is added. With a great number of series, it becomes very difficult to read with accuracy the difference between "9 Series" and "10 Series", for example. However, it is possible to see meter movement as

each series is connected, and this should be closely observed during "hookup".

PARALLEL CIRCUIT.—A parallel circuit cannot be tested with the instruments usually available in field operation as the total resistance of the circuit is so small it will read close to zero resistance on the instrument and will not indicate a meaningful reading.

6.4.7. Locating a Break in the circuit. Either a Blaster's Multimeter, Blasting Ohmmeter, or Galvanometer can be used for locating a break in a series circuit. When testing for a break in the circuit using the procedure shown in figure 21, attach a connecting wire to the end of the circuit from terminal "A". Then attach another connecting wire to terminal "B". Pick a point midway in the circuit and touch the connecting wire from terminal "B" to the bare connection of the cap wires. If a reading is indicated on the instrument, the circuit is good between terminal "A" and the midpoint of the circuit. Continue moving the connection wire from terminal "B" to connections further along the circuit until no reading is indicated on the instrument. In this manner the break in the circuit has been isolated and can be corrected.

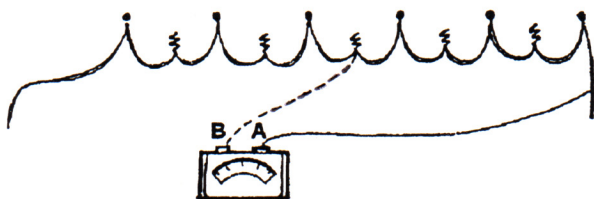

Recommended method for locating circuit break with galvanometer.

Figure 21

CURRENT LEAKAGE.—Current leakage is the loss of part of the firing current through the ground which bypasses a portion of the firing circuit. This occurs when the insulation on the cap wires has been damaged or abraded during loading, when bare connections between holes contact the ground, or when poorly insulated splices are placed in a borehole. Cap failures are likely to occur unless the condition is recognized and preventive

measures are taken.

The amount of current loss is determined by many factors, with the conductivity of the rock being the principal one. Leakage can occur in relatively nonconductive formations if the ground is wet. Moist ANFO and "WG" explosives are conductive and will permit current flow to the rock formations if damaged leg wire insulation is present in the borehole. Before it can be controlled, current leakage must be first identified as a problem using the Blaster's Multimeter. The test can be made by connecting one lead of the Multimeter to a cap or cap series and the other lead to a good earth ground such as a bare wire inserted into a wet hole.

Experience has shown that current leakage can be a potential problem whenever the true resistance between a cap series and ground is less than 25 times the resistance of one series. It should be recognized, however, that because of polarization effects at the electrodes, a DC meter such as the Blaster's Multimeter may show a ground resistance several times higher than the true resistance. The polarization effects will also cause the readings on the three scales to be different and only the X100 and X1000 scales on the Multimeter should be used. If resistance readings less than 5000 ohms are obtained, find the source of leakage and correct.

REDUCING THE POSSIBILITY OF CURRENT LEAKAGE.—If conditions conducive to current leakage are known prior to blast preparation, the following steps can be taken to reduce the possibility of current leakage:

- Use care in loading boreholes to reduce the chance for abraded insulation.
- Make sure all connections do not touch ground.
- Avoid the use of splices in bore holes.
- Use a blasting machine with the capability of firing a large number of caps.
- Stay well below the maximum number of caps that the blasting machine is of firing under normal field conditions

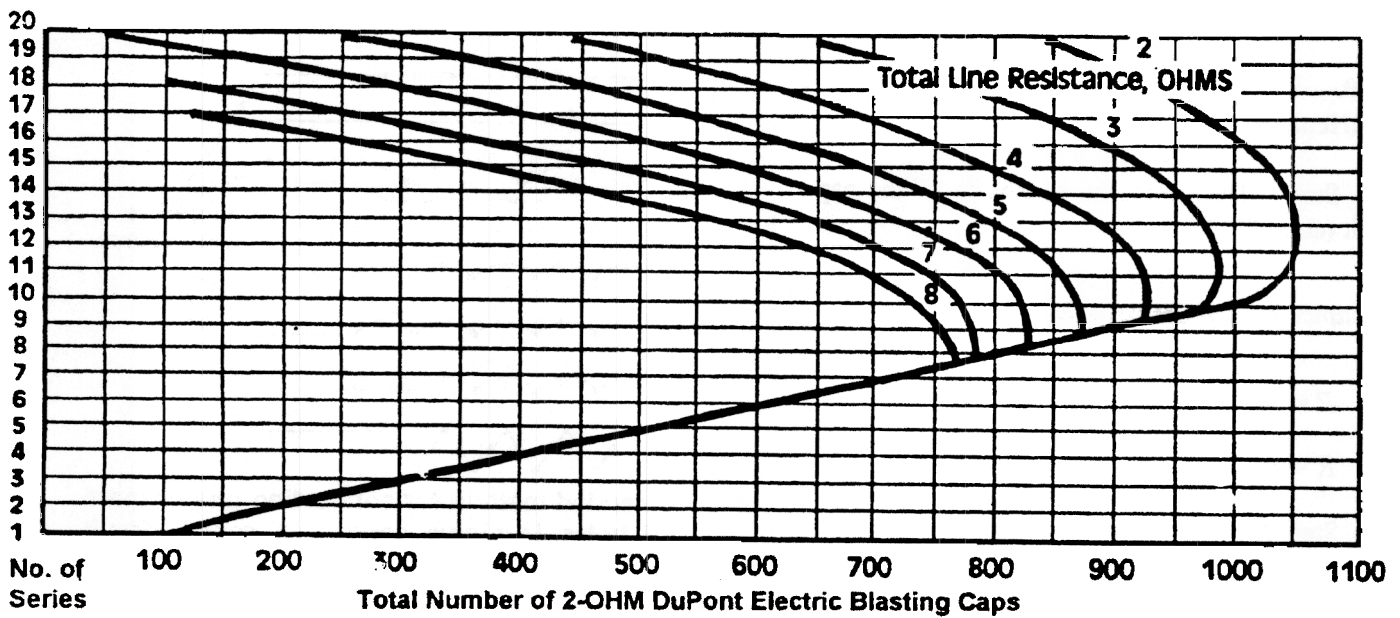

Recommended Firing Limits for DuPont CD-600 Blasting Machine

Figure 22

of firing under normal field conditions

- Use heavier gauge lead lines to supply more energy to the blasting circuit.
- If a bus wire arrangement is used, reduce the bus wire resistance by shortening its length and/or using heavier gauge wire.

6.4.8. Capacitor Discharge Firing. Capacitor discharge blasting machines, when used properly, are the most dependable means of firing electric blasting caps. The firing limits for the CD-600 Blasting machine have been determined from experience and computer analysis to assist the user in designing the electrical circuitry for blasting with electric blasting caps. Figure 22 shows a graph to calculate the limits of the blasting machine. The graph is based on 2.0 ohms-per-cap resistance. It may be used for DuPont instantaneous or delay caps of any length. Simply multiply the number of caps in the blast by the resistance of the individual caps being used. Then divide by 2.0 ohms to find the equivalent number of 2.0 Ohm caps for use on the graph.

$$\frac{\text{No. of Caps in Blast} \times \frac{\text{Ohms}}{\text{Cap}}}{2} = \text{Equiv. No. of 2.0 Caps}$$

The resistance in ohms, for various length DuPont electric blasting caps is shown in chart "D". The resistance of various wire gauges is shown in chart "E". The total number of 2.0 caps in the blast is shown across the bottom of the graph and the number of series to be used is shown vertically. The area within the curves and above the straight line represents the recommended firing range and should not be exceeded. The heavy curved lines represent recommended firing limits for the designated lead line resistance.

6.4.9. Series Circuit. A series circuit provides a single path for the current through all caps. Figure 23 shows an example of typical series circuits.

6.4.10. Using Figure 22 to Determine The Electrical Circuitry of a Blast.

Step 1: Determine the resistance of the cap circuit (chart "D").

$$\text{Resistance of Cap Circuit} = \text{No. of Caps} \times \frac{\text{Resistance}}{\text{Cap}}$$

$$R = 50 \times 1.65$$

$$R = 82.5 \text{ Ohms}$$

Step 2: Determine the equivalent number of 2.0 ohm caps (chart "D").

$$= \frac{50 \times 1.65}{2.0}$$

$$= 41 \text{ Caps}$$

Step 3: Determine resistance of the lead line (chart "E").

A 300- foot lead line has 600 feet of wire (300 feet x 2 conductors=600 feet).

$$\text{Resistance of Lead Line} = \frac{\text{Len. of Wire} \times \frac{\text{Resistance}}{1000 \text{ Ft.}}}{1000}$$

$$R = \frac{600 \times 2.525}{1000}$$

$$R = 1.515 \text{ Ohms}$$

Step 4: Determine the resistance of the connecting wire

$$\text{Equivalent No. of 2.0 Ohm Caps} = \frac{\text{No. of Caps} \times \text{Ohms / Cap}}{2.0}$$

$$R = \frac{200 \times 10.15}{1000}$$

$$R = 2.03 \text{ Ohms}$$

Step 5: Determine the total external resistance.

$$\text{Resistance} = \text{Lead Line} + \text{Connecting Wire Resistance}$$

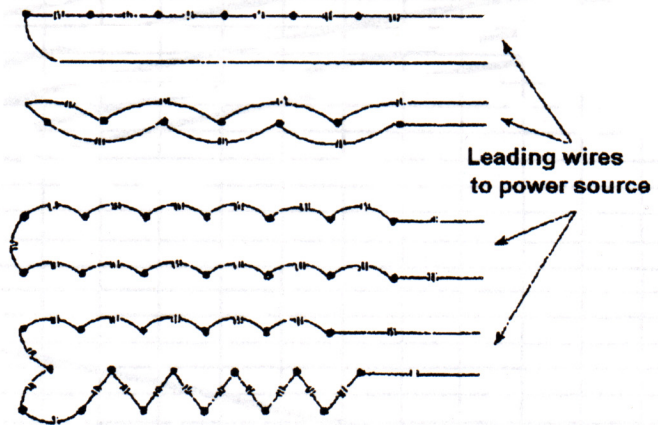

Recommended method for connecting one or more rows of holes in single series. A series circuit provides a single path for the current through all of the caps.

Figure 23

$$R = 1.515 + 2.03$$

$$R = 3.5 \text{ Ohms}$$

Step 6: Consult graph (fig 22)

The 41 equivalent number of caps falls well within the allowable lead line resistance of 3.5 ohms. Therefore, this blast can be fired in a single series by the DuPont CD-600 Blasting Machine.

6.4.11. Series-in-Parallel. This is the most common type of circuit used in blasting. The simplest series-in-parallel circuit is made by dividing a single series into two series as shown in figure 24. As shown, each of the two rows of electric blasting caps is connected in a straight series. The two free ends from each series are connected together and then are connected to the

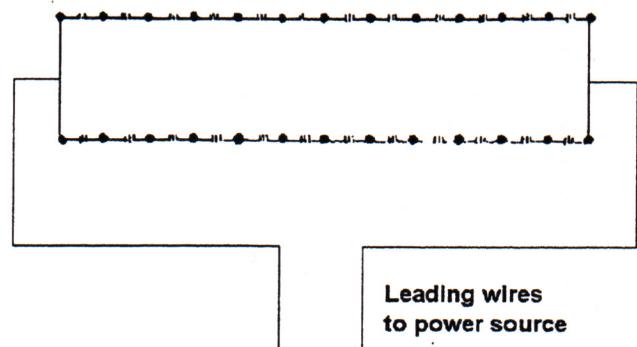

Simplest series-in-parallel circuit is made by dividing a single series into two series. The two free ends from each series are then connected to the lead lines.

Figure 24

lead line.

The main advantage of the series-in-parallel circuit is the large number of caps which can be fired from a blasting machine without a large input voltage requirement. A series-in-parallel hookup with five balanced series is shown in figure 25.

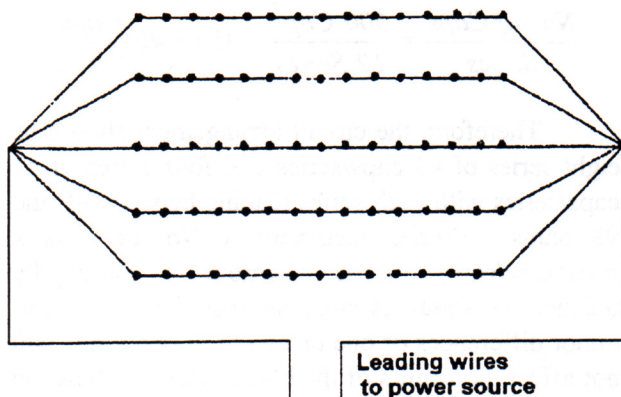

Main advantage of the series-in-parallel is large number of blasting caps that can be fired from the blasting machine without large input voltage requirement.

Figure 25

Blasts of over 1000, electric blasting caps have been fired from capacitor discharge blasting machines, and blasts of about 500 electric blastings caps are very common. When a series-in-parallel circuit involves only delay caps, a minimum current of 2.0 amperes is required for each series because of the relatively fast functioning time of instantaneous caps. For this reason, we do not recommend use of instantaneous and delay caps in the same blast.

When connecting a series-in-parallel blast, the ends of each individual series should be connected to the lead line by extending the ends of each series with the use of connecting wire. This will add some resistance to each series, but the added resistance is normally small when compared to the series resistance.

Bus lines are sometimes used to connect individual series in parallel. This method offers some advantages in simplicity of wiring, but the use of bus wires can result in an uneven current distribution and can cause failures in one or more series, usually those located farthest from the power source. If it is absolutely necessary to use bus wires, the following "rule of thumb" should be

applied. The Maximum allowable resistance of one bus wire should not exceed the total resistance of all the electric blasting caps in the blast divided by 1,000. Should the bus wire resistance be too high, the wire must be shortened or a lower resistance bus wire must be used.

Example 4: Assume a blast of 500 40-foot MS Delays and 300-foot, 20-gauge copper bus wires:

Step 1: Determine the resistance of all the caps in the blast (Consult chart "D" for cap resistance).

$$\text{Resistance of Caps} = \text{No. of Caps} \times \frac{\text{Resistance}}{\text{Cap}}$$

$$R = 500 \times 2.06$$

$$R = 1030 \text{ Ohms}$$

Step 2: Determine the resistance of one bus wire (Consult chart "E" for wire resistance).

$$\text{Resistance of Bus Wire} = \frac{\text{Len. of Wire} \times \frac{\text{Resistance}}{1000 \text{ Ft.}}}{1000}$$

$$R = \frac{300 \times 10.15}{1000}$$

$$R = 3.045 \text{ Ohms}$$

Step 3: Determine if the resistance of one bus wire exceeds the total resistance of the cap circuit divided by 1000.

$$\text{Resistance of One Bus Wire} = 3.045 \text{ Ohms}$$

$$\frac{\text{Resistance of Cap Circuit}}{1000} = 1.030 \text{ Ohms}$$

Therefore, the bus wire resistance is almost three times as large as the total resistance of the caps divided by 1,000, and failures would be expected. If the size of the 300-foot bus wire were increased to 13 gauge, its resistance would be 0.76 ohms and the "rule of thumb" would be satisfied.

Example 5: Assume a blast of 500 50-foot

copper wire DuPont MS Delay Caps. The blast is to be fired with a DuPont CD-600 Blasting Machine using 750 feet of 14-gauge single conductor, solid copper wire lead line. To determine the proper circuit arrangement from the graph in figure 17, the following steps are required:

Step 1: Determine the equivalent number of 2.0 ohm caps (Consult chart "D" to determine the resistance of a 50-foot copper MS Delay Cap). The resistance is 2.32 Ohms.

$$\text{Equiv. No. of 2.0 Ohm Caps} = \frac{\text{No. of Caps} \times \frac{\text{Ohms}}{\text{Cap}}}{2.0 \text{ Ohms}}$$

$$\text{Equiv. No. of 2.0 Caps} = \frac{500 \times 2.32}{2.0} = 580 \text{ Caps}$$

Step 2: Calculate the lead line resistance. Consult chart "E" for the resistance of 14-gauge copper wire. A lead line 750 feet long x has 1500 feet of wire (750 x 2 conductors=1500 Ft. of wire).

$$\text{Resistance} = \text{Length of Wire} \times \frac{\text{Ohms}}{1000 \text{ Ft.}}$$

$$R = \frac{1500 \times 2.525}{1000} = 3.79 \text{ Ohms}$$

Step 3: Consult graph (fig 22) and locate 580 on the bottom of the graph.

Step 4: Follow the 580 cap line vertically into the area above the straight line until it intersects the 4.0 ohm total line resistance curve. From the bottom and top intercept points follow across the graph to determine the number of balanced series that will be within the energy limits of the blasting machine. As shown, the acceptable limits are between six and 18 series. The optimum energy would be delivered by choosing a circuit

arrangement approximately midway between the extreme limits of six to 18 series. In this example, it would be 12 series.

Step 5: Divide the total number of caps in the blast by the number of wires to determine the number caps per series.

$$\frac{\text{No. of Caps}}{\text{Series}} = \frac{500 \text{ Caps}}{12 \text{ Series}} = 41 \text{ or } 42 \frac{\text{Caps}}{\text{Series}}$$

Therefore, the circuit arrangement should be eight series of 42 caps/series and four series of 41 caps/series with each series reading between 95 and 98 ohms. (Series resistance = No. of caps x resistance/cap.) It is desirable to electrically balance the series as close as possible. However, minor differences of one or two caps per series will not affect the results of the blast. The difference in resistance, in ohms, between series should never exceed 10 percent. And even 10 percent cannot be tolerated if the circuit arrangement is approaching the limits of the machine.

For normal blasting it is customary to limit the number of copper leg wire caps to 50 per series (120 ohms per series.) For the Du Pont CD -600 this is readily accomplished when firing up to 800 caps with a larger number of caps per series is required for maximum transfer of energy between the blasting machine and blasting circuit.

Example 6: Assume a blast of 900 40-foot copper DuPont MS Delays. The blast to be fired with a DC-600 Blasting Machine using 800-foot lead line of 12-gauge single conductor copper wire.

To determine the proper circuit arrangement, the following steps are required:

Step 1: Determine the equivalent number of 2.0 ohm caps. Consult chart "D" to determine the resistance of a 40-foot copper wire MS Delay. The resistance is 2.06 Ohms/caps.

$$\text{Equivalent No. of 2.0 Ohm Caps} = \frac{\text{No. of Caps} \times \frac{\text{Resistance}}{\text{Caps}}}{2.0 \text{ Ohms}}$$

$$\text{Equivalent No. 2.0 Caps} = \frac{900 \times 2.06}{2} = 927 \text{ Caps}$$

Step 2: Calculate the total lead line resistance. Consult Chart "E" for the resistance of 12-gauge copper wire. This is 1,588 ohms per 1000 feet.

800 Ft. x 2 Conductors = 1600 Ft. of Wire

$$\text{Resistance} = \frac{1600 \times 1.588}{1000} = 2.54 \text{ Ohms}$$

Step 3: Consult graph (fig 22) and locate 927 on the bottom of the graph.

Step 4: Follow the 927 cap line vertically into the area above the straight line until it intersects the 3.0 ohm Total Line Resistance curve. From the intercept points follow across the graph to determine the number of balanced series that will be within the energy limits of the blasting machine. As shown the acceptable limits are between 10 and 15 series. The optimum energy would be delivered by choosing a circuit arrangement approximately midway between the extreme limits of 10 to 15 series. In this example, it would be 12 series.

Step 5: Divide the total number of caps in the blast by the number of series to determine the number of caps per series.

$$\text{No. of Caps / Series} = \frac{900 \text{ Caps}}{12 \text{ Series}} = 75 \frac{\text{Caps}}{\text{Series}}$$

The resistance per series should equal 154.5 ohms.

$$\left(\text{Resistance} = \text{No. of Caps} \times \frac{\text{Resistance}}{\text{Cap}} \right)$$

Example 7: Assume 120 16-foot Iron Wire Du Pont "Acudet" Delays. The blast is to be fired with a CD-600 Blasting Machine using 500 feet of 14-gauge copper wire lead line. To determine the proper circuit arrangement the following steps will be required:

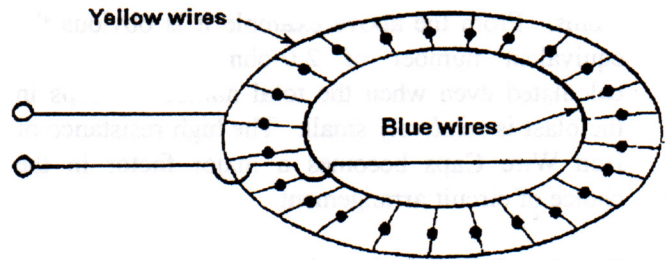

Where several men will be involved in the wiring of the circuit, one copper bus line can be designated for the yellow leg wire and the other for the blue leg wire.

Figure 26

Step 1: Determine the equivalent number of 2.0 ohm caps. Consult chart "D" to determine the resistance of a 16-foot Iron Wire Delay. The resistance is 4.98 ohms per cap.

$$\text{Equivalent No. of 2.0 Ohm Caps} = \frac{\text{No. of Caps} \times \frac{\text{Ohms}}{\text{Cap}}}{2.0 \text{ Ohms}}$$

$$\text{Equivalent No. of 2.0 Ohm Caps} = \frac{120 \times 4.98}{2} = 299 \text{ Cap.}$$

Step 2: Calculate the lead line resistance. Consult chart "E" for the resistance of 14-gauge copper wire. This is 2.525 ohms/1000 feet of wire.

500 Ft. x 2 Conductors = 1000 Ft. of Wire

$$R = \frac{1000 \times 2.525}{1000} = 2.525 \text{ Ohms}$$

Step 3: Since the equivalent number of caps is only 299, we find that the graph gives many choices for the number of series-in-parallel. One option is to limit the equivalent number of copper leg wire caps to 50 caps-per-series, or six series in this example.

Therefore:

$$\frac{\text{No. of Caps}}{\text{Series}} = \frac{\text{Total No. of Caps}}{\text{No. of Series}}$$

$$\frac{\text{No. of Caps}}{\text{Series}} = \frac{120}{6} = 20 \frac{\text{Caps}}{\text{Series}}$$

The resistance per series would be 99.6

Ohms. From the above example it is obvious the equivalent number of 2.0-ohm caps must be calculated even when the total number of caps in the blast is relatively small. The high resistance of Iron Wire Caps becomes a major factor in the choice of circuit arrangement.

6.4.12. Parallel Circuits. Parallel circuits are used for simplicity of wiring in many high-speed tunnel and shaft sinking operations. Where several men will be involved in the wiring of the circuit, one copper bus line can be designated for the yellow leg wire from each cap, and the other copper bus line can be designated for all the blue leg wires, as shown in figure 26. This method will allow the blaster in charge of the operation to tell by visual inspection if all caps have been properly connected to the bus lines.

Copper bus lines should be installed on stakes as shown in Figure 27. It is extremely important to insure that the stakes are dry, as water soaked stakes may allow a conductive path between the bus lines. If necessary, electricians' tape should be wrapped around the stake at the contact points

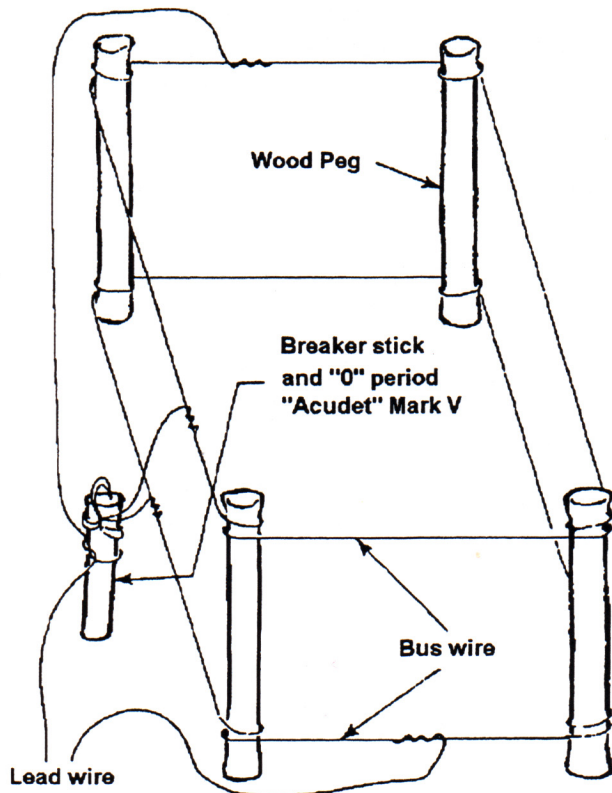

Method for installation of the breaker cap to interrupt a parallel circuit.

Figure 27

to avoid any current leakage between bus lines.

The bus wires should be shunted during the loading operation, and special attention should be given to the removal of the shunt prior to firing.

The four basic forms of paralleled circuits are shown in Figure 28. The voltage, wire size and number of caps which can be fired will be greatly affected by the choice of parallel circuit. The circuits can be rated by their ability to distribute the current uniformly.

- Straight parallel: Causes very poor current distribution and is not recommended.
- Reverse parallel :Better than straight parallel but not recommended.
- Closed-loop straight parallel Better than straight parallel but not recommended.
- Closed-loop reverse parallel:
Produces the most even current distribution and is strongly recommended for all parallel circuits.

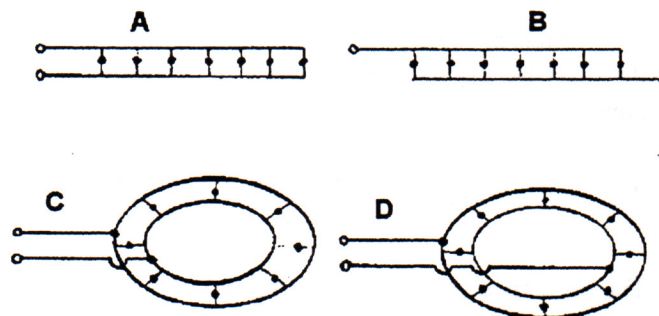

Here are four variations in parallel circuits: A-Straight parallel (upper left), B-Reverse parallel (upper right), C-Closed loop straight parallel (lower left), D-Closed loop reverse parallel (lower right). A, B, & C all have shortcomings and are not recommended. variation D is recommended as it produces the most even current.

Figure 28

6.5. SAFETY.

6.5.1. General Safety Precautions:

- Maintain minimum safe distances between electromagnetic-radiating sources and electro-explosive devices.

- Do not conduct blasting operations during

an electrical, dust, sand, or snow storm of a severity great enough to produce atmospheric static electrical charges, or when such a storm is nearby (approximately 5 miles). Under such conditions, all operations will be suspended, cap and lead wires short-circuited, and personnel removed from the blast site.

- When an electromagnetic radiation hazard is present, use the preferred, nonelectric firing system for conducting blasting operations.

- Observe all applicable safety precautions during training with inert materials, to promote safe operating procedures for use with live items.

- Do not work with electric blasting caps or other electro-explosives devices while wearing static-electricity producing clothing (nylon, silk, synthetic hair, etc.).

- Do not ingest any explosive material.

- Do not get in the smoke of burning explosives. The smoke will penetrate ordinary clothing and severe dermatitis may result.

- Do not inhale the gaseous products of high explosive detonations. Certain of the gases produced are highly toxic.

- Do not permit more than the required types and amounts of explosive required for the operation to be brought to the blast site.

- Carry blasting caps in approved containers, and keep them out of the direct rays of the sun.

- Do not handle, use, or remain near explosives during the approach or progress of an electrical storm.

- Do not use explosives or accessory equipment that are obviously deteriorated or damaged. They may detonate prematurely or fail completely.

- Do not abandon any explosives.

- Do not leave explosives, empty cartridges, boxes, liners or other materials used in the packing

of explosives lying around where children or unauthorized persons or livestock can get at them. Fatal or serious accidents can result from such careless practice.

- Do not allow any wood, paper, or other materials used in packing explosives to be burned in a stove, fireplace, or other confined space, or to be used for any purpose. Serious accidents can result. Such materials should be destroyed by burning at an isolated location out of doors, and no person should be permitted nearer than 100 feet after burning has started.

- Do not continue to fight fires after they have come in contact with explosives. Remove all personnel to a safe location and guard the area against intruders. A detonation is probable once the explosive begins to burn.

6.5.2. When Preparing the Primer:

- Do make up primers in accordance with established methods. Make sure that the detonator is completely encased in the explosive and so secured that in loading no tension will be placed on the wires safety fuse or detonating cord at the point of entry into the detonator.

- Don't force a detonator into an explosive material. Insert the detonator in a hole made with a punch suitable for that purpose.

- Don't make up primers in a magazine or near other large quantities of explosive materials and don't make more than are necessary for immediate needs.

- Test all electric caps prior to using.

- Don't use sparking metal tools to open explosives containers.

- Do not smoke or have matches or any source of fire or flame within 50 feet of an area in which explosives are being handled or used.

- Do not place explosives where they may be exposed to flame, excessive heat, sparks or impact.

- Do not replace or close the cover of explosive cases or packages after using.

- Do not carry explosives in the pocket of your clothing or elsewhere on your person.

- Do not insert anything but fuse in the open end of a blasting cap.

- Do not strike, tamper with or attempt to remove or investigate the contents of a blasting cap or try to pull the wires of an electric blasting cap.

- Do not allow children, unauthorized or unnecessary persons to be present where explosives are being handled or used.

- Do not handle, use or be near explosives during the approach or progress of any electrical storm. All persons should retire to a place of safety.

- Do not use explosives or accessory equipment that are obviously deteriorated or damaged.

- Do not attempt to reclaim or use fuse, blasting caps or any other explosives that have been water soaked, even if they have dried out.

6.5.3. When Drilling and Loading.

- Recognize the possibility of static electrical hazards and take adequate precautionary measures.

- Carefully examine the surface or face before drilling to determine the possible presence of unfired explosive materials. Never drill into explosive materials or into any hole that has contained explosive materials.

- Be sure all holes are cleaned out prior to loading.

- Don't force explosive materials into a borehole.

- Tamping sticks should be made of wood. They may be joined with non ferrous metals. Don't tamp the primer. Avoid violent tamping and don't churn.

- When loading or tamping, do not bend forward, keep the head and body back away from the borehole.

- Don't slit, drop, deform, tamp or abuse the primer and don't drop another cartridge directly on the primer.

- Insure the lead wires and detonation cord are not damaged in the process of tamping.

- Stemming material should not contain rocks of any kind. Drill cuttings are ideal for stemming.

- Don't stack more explosive materials than are needed near working areas during loading.

- Spring Holes. For many years it was a common practice to drill small diameter holes and spring or chamber the bottom of the hole to allow room for additional explosives as a bottom load. This practice is extremely hazardous and has been largely abandoned with the technical advances in drilling equipment. It is therefore discontinued within the NCF.

- Do not fight fires in explosive materials. Remove all personnel to a safe location immediately and guard the area against intruders.

CHAPTER 7

MISCELLANEOUS BLASTING

7.0. MISCELLANEOUS USES OF EXPLOSIVES. Explosives provide a source of concentrated energy that can be used in many ingenious ways. This chapter presents a brief description of the more common miscellaneous uses of explosives. The Dupont Blasters Handbook provides information on a wide variety of types of blasting.

7.1. TRENCHING. When blasting vertical wall trenches for water or sewer lines, the methods recommended for open drainage ditches are not applicable because the soil is blown away, the top is too wide, and back filling expensive. In addition this method of blasting is feasible only in isolated locations.

7.1.1. Vertical Wall Trenches. For vertical wall trenches through rock formations, such as could be required for water or sewer lines, a drilling and blasting technique is needed that will shatter the rock in place and loosen overlying earth to permit easy removal by backhoe. In the majority of trenching jobs primary requirements are the minimization of:

- Overbreak.
- Vibration.
- Noise.
- Flying material because of close proximity to buildings, existing utility lines, and valued landscapes.

Recommendations to meet these requirements include the use of:

- Rock drills capable of drilling 2-1/2 to 3-1/2 inch diameter holes.
- A small number of holes per blast.
- Minimum explosive load per hole to break the rock (including decking through mud seams).

- Delay electric blasting caps.
- "WG" explosives to avoid propagation between adjacent holes.
- Blasting mats to reduce the possibility of flying material.

Holes should be drilled about one foot from the desired boundary lines of the trench. Subdrilling of one to two feet is used to assure excavation to grade line. Spacing between holes and quantity of explosives per hole are varied in accordance with the type (open face vs. tight) and size of blast as well as with the breaking characteristics and homogeneity of the rock. MS Delay blasting is generally preferred for sequence firing of charges in order to minimize vibration and produce maximum fragmentation.

7.2. CUTTING TIMBERS. High explosives can easily and quickly shear trees, piles, posts, or structural timbers. The amount of charge depends on the diameter of the timber and the placement of the charge. The following formulas apply to tree cutting:

External Charge

$$\frac{D^2}{40} = \text{Lbs. of TNT}$$

Internal Charge

$$\frac{D^2}{250} = \text{Lbs. of TNT}$$

7.3. SMOOTH BLASTING. Sometimes referred to as contour blasting, perimeter blasting, or sculpture blasting. In smooth blasting the holes are drilled along the excavation limits, lightly loaded with well distributed charges, and fired after the main excavation is removed. By shooting instantaneously or with minimum delay between the holes, a shearing action is

obtained which gives smooth walls with minimum overbreak.

7.4. PRESHEARING. Preshearing involves a single row of holes drilled along the neat excavation line. The holes are loaded and fired before any of the adjoining main excavation area is blasted. The theory of preshearing is that some of the radial cracks from a lightly shot borehole either join an adjacent hole or other radial cracks from an adjacent hole to form a plane of broken rock between the holes. This cracking

between boreholes, initially produced by the shock wave of the explosive, is subsequently extended and widened by the expanding gases. Depending on several factors including the properties and conditions of the rock, the spacing between holes and the amount of explosive in the holes the fractured zone between the holes may be a single, narrow crack or a thick zone of fractured rock. This split or crack in the rock forms a discontinuous zone which minimizes or eliminates overbreak from the subsequent primary blast and produces a smooth, finished rock wall.

CHAPTER 8

TRANSPORTATION AND HANDLING

8.0. DRIVER QUALIFICATIONS. Navy and Marine Corps applicants for explosives driver shall meet the following qualifications to drive motor vehicles transporting hazardous materials. These qualifications are detailed in NAVSEA OP 2239 and Title 49 CFR, Part 391. Information contained in this part is not to supersede NAVSEA OP 2239 or any Federal or state regulations.

8.1. STATE LICENSE. Applicants must hold a valid state operator's license. This license does not necessarily have to be from the state at which the activity is located. Further, if the applicant is stationed outside the 50 states and meets all other requirements, the license requirement is permanently waived.

8.2. MEDICAL EXAMINER'S CERTIFICATE. Applicants must undergo an annual physical examination conducted by a licensed doctor of medicine. This examination is intended to uncover any physical condition which may hamper safe operation of a motor vehicle. Disqualifying and waivable physical conditions are provided by the federal motor carrier safety regulations. A current medical examiners certificate must be carried by the operator at all times.

8.3. EXPLOSIVES DRIVER PERMIT. Applicants shall hold a valid U.S. Government Motor Vehicle Operator's Identification Card, SF 46 or O.F. 346. These must be endorsed "Explosive Driver". Endorsement is invalid if medical examiners certificate is expired. Annual endorsement is not required. However, the individual's safety record and physical requirements are taken into account prior to recertification as an explosives driver.

8.3.1. Physical Requirements. Title 49 CFR, Parts 391.41-391.49, list the details concerning what physical requirements must be met to safely operate a motor vehicle.

EYESIGHT.—Special Attention Is placed on:

- Distant visual acuity of at least 20/40 (snellen) in each eye without corrective lenses.
- No loss of vision in either eye
- No color blindness
- Ability to distinguish between red, yellow and green in any combination
- Not cross-eyed.

HEARING.—No hearing loss In either ear greater than 40 decibels at 500 HZ, 1,000 HZ and 2,000 HZ with or without a hearing aid.

HEART.—No medical history of heart, vascular, and/or respiratory disease likely to interfere with safe motor vehicle operation.

OTHER.—No loss of limbs or other physical defects.

8.3.2. Mental Requirements. Applicants must pass a mental examination administered by the local command prior to consideration as an explosives driver.

8.3.3. Age And Experience. For on-station explosives transport, drivers shall be 18 years of age or older. They shall be 21 years of age or older for off-station transport. They shall have demonstrated driving experience with the type of vehicle to be operated and shall have a safe driving record.

8.3.4. Alcohol And Drugs. Applicants shall be disqualified if found addicted to alcohol or drugs. Explosives drivers who are found under the influence of alcohol and/or drugs while on duty shall have their

certification revoked. If the driver is taking physician prescribed medication which is likely to interfere with the safe operation of a vehicle, the certification is temporarily revoked until therapy is complete.

8.3.5. Literacy And Comprehension. Applicants shall be able to read, write and understand English. This includes the ability to complete various required forms, and the understanding of Navy and federal regulations as applicable.

8.4. TRAINING REQUIREMENTS. Applicants must successfully complete at least 12 hours of instructions and training for driving trucks (truck trailers with semi-trailers); handling and transporting hazardous materials; regulations and procedures for transporting hazardous materials; proper use of fire extinguishers; and, completing and filing required reports. In addition to this initial training, the Explosives Driver should attend a motor vehicle inspection course offered by the U.S. Army Defense Ammunition Center and School (USADACS). They should take a personal interest in reading safety bulletins and periodicals to keep up-to-date on current safety practices and regulations.

8.5. DRIVER'S RESPONSIBILITY. All personnel engaged in the operation of Navy-owned vehicles must comply with Department of Defense regulations as well as federal and state laws. They are personally liable for fines and/or imprisonment when in violation of the regulations/laws.

8.5.1. Safe Driving Habits. Explosives drivers shall comply with all traffic regulations, signs, and signals. They are expected to yield to pedestrians and practice courtesy towards other drivers. An explosives driver shall not be permitted to drive if his alertness is affected by some physically or mentally disqualifying condition.

8.5.2. Local Speed Regulations. No motor vehicle transporting explosives shall travel faster than the posted maximum speed limit nor slower than the minimum speed so as not to impede traffic.

8.5.3. Reckless Or Drunken Driving. Military drivers are subject to UCMJ, Article 111, when driving in a reckless or drunken manner. Civilian drivers are subject to local laws.

8.5.4. Disciplinary Actions And Penalties. All traffic violations and accidents are reported to the security or safety officer. Drivers are subject to disciplinary actions and penalties, both civil and military. The Commanding Officer shall suspend or revoke a Navy driver's permit if he deems it in the best interest of the Navy.

8.5.5. Automatic Revocation Of License. Navy driver's permits shall be revoked automatically for the following violations:

- a. Driving while under the influence of alcohol or drugs.
- b. The known transportation, possession or unlawful use of drugs, such as amphetamines, narcotics or their derivatives.
- c. Failing to report an accident in which the driver was involved.
- d. Leaving the scene of an accident in which the driver was involved.
- e. Smoking while in or within 25 feet of a vehicle loaded with hazardous materials.
- f. Revocation of state driver's license.

First offenders of violations 8.5.5.(a)-8.5.5.(d) shall be disqualified for one year from date of conviction. If a driver is convicted of a subsequent offense within 3 years of a prior offense, the driver shall be disqualified for 3 years.

8.5.6. Reinstatement. Reinstatement shall be granted only with the permission of the Commanding Officer. After requisite waiting period, the driver must pass the mental and physical requirements as well as retake the driver's test.

8.6. Forms And Reports. During operations, on station, or off station, explosives drivers are required to carry on their person the U.S. Government motor vehicle operator's identification card (SF 46) or OF 346 and a current medical examiner's certificate. Other forms required to be in the vehicle are as follows:

- **DD Form 1970.** Motor vehicle utilization record DD Form 1970 is completed each time a navy vehicle is used for on station or off station operations.

- **SF 91.** Operator's report of motor vehicle accident SF 91, shall be completed each time a navy vehicle is involved in an accident.

- Trip route maps and inspection station stops.

- **DD Form 626.** Motor vehicle inspection report, DD Form 626, is a vehicle inspection form that lists the vital parts to be checked on a motor vehicle before it can be certified safe to carry explosives. The form is used to inspect the mechanical condition of the motor vehicle as well as the inspection of the loaded cargo. It is completed each time a motor vehicle carrying explosives arrives or leaves the activity. The driver accepts or rejects the vehicle and load. The driver must insure that all safety warning and emergency equipment and forms are in his possession before accepting the load.

- **Shipping documents** carried by the driver may include the DOD single line item release receipt document, DD Form 1348-1 or the material inspection and receiving report, DD Form 250. The document used must contain the following information:

- Hazard and freight description.

- Item nomenclature.

- Total quantity of weight (gross and net), volume, number, etc.

- Prescribed labels on containers.

- Other necessary information or instruction.

- Authenticated by proper authority.

- **Shipping Papers.** Each motor vehicle carrying Class A, B, or C explosives, ammunition or related materials must have a duplicate copy of the shipping papers placed in a transparent, heat sealed envelope. The envelope is nailed to the floor of the trailer at the rear end in a readily accessible location for flatbed loads. Otherwise, the envelope is nailed or taped to the inside of the rear door.

- **DD Form 836.** Special instructions for motor vehicle drivers, DD Form 836, is carried by each driver transporting explosives over public roads. It contains instruction applicable to the load being carried. The special instructions cover safety precautions and emergency measures to be taken in the

event of fire, accident, breakdown, stopping and parking, and special precautions for the load. The driver must read, understand, sign, and carry this form while in transit.

- **DD Form 1907.** Signature and tally record, DD Form 1907, is used to obtain a signature and tally record from each person responsible for the safe handling of explosives.

- **Delays or Breakdowns.** Reports for delays or breakdown are noted in the "remarks" section on DD Form 1970. Delays of 5 hours or longer must also be reported to the home command as soon as possible with a follow-up written report of specific cause(s) of delay. This report is submitted to the dispatcher in the home station.

- **NAVSEA OP 2239.** A copy of the NAVSEA OP 2239 (current) Motor Vehicle Driver's Handbook Ammo, Explosives, and Related HM must be kept in the motor vehicle.

8.7. VEHICLE SPECIFICATIONS. Class A, B, or C explosives may be transported via cargo carrying vehicles such as trucks, full trailers, semi-trailers and double trailers equipped with closed bodies, flatbeds, stake sides, dromedary containers and open tops. These vehicles shall not have two-way radios if carrying electric caps.

- Fully closed vehicles shall have an exterior made of fireproof or fire resistant material. The interior walls shall be of wood or non-sparking metal. The doors shall be affixed to hinges with latches and operational locks.

- The use of double trailers is authorized if delivery can be accomplished without transfer of the cargo; if the coupling device and towing methods comply with 49 CFR 393.70(a)-(c); and if the cargo in each trailer is compatible.

- Pick-up, flatbed, stake side or open top vehicles carrying explosives shall be covered with waterproof, fire resistant tarpaulins securely fastened to the vehicle. This is a precaution used to prevent entry of sparks, fire and moisture. If the load is palletized or packed in large wooden or metal containers, then a

flatbed truck may be used. The load must lie flat; lie entirely within the edges of the flatbed with no overhang or projections; and must be secured and braced to prevent moving or shifting.

- Header boards shall be provided to protect the driver from shifting cargo and possible cab penetration due to sudden stops or collisions. This applies to closed motor vehicles.

- Fire extinguishers shall be securely mounted on vehicles.

8.8. VEHICLE INSPECTION AND LOADING.

8.8.1. Before Loading. Appendix C of NAVSEA OP 2339 (5th revision) thoroughly covers the checkpoints required before the vehicle shall be loaded. The results of the inspection are recorded on the inspection report, DD Form 626. Any discrepancies shall be corrected prior to loading or vehicle movement. Both the driver and shipping director must sign this form.

8.8.2. Loading And Handling Regulations. The same care must be shown in loading and handling of explosives as in preparing the vehicle to receive this cargo.

FORBIDDEN MATERIALS.—A complete list of forbidden materials is provided in the Department of Transportation (DOTR) regulations, paragraph 173.51. These materials are too impact sensitive or may ignite from spontaneous combustion and are not allowed to be transported by a motor vehicle.

PRECAUTIONS.—Cargo Handling precautions. Appendix D of NAVSEA OP 2239 contains a chart showing which cargo contents are incompatible and shall not be loaded as one cargo. Although it is the responsibility of the shipping director to insure cargo compatibility, the driver shall make a visual check as an added precaution.

PACKAGES.—During loading, packages shall be handled carefully so that the explosives do not slide, fall or shift during transit. Packages shall not be thrown, dropped, slid, pulled or tumbled while being loaded or unloaded. Materials unloaded shall be placed a sufficient distance from the vehicles exhaust tailpipe to prevent sparks or hot gases from igniting the material when the motor is restarted.

RESPONSIBILITIES DURING LOADING.—The driver shall ensure that:

- The vehicle is positioned correctly.
- The engine is off.
- The handbrake is securely set, the wheels chocked and the transmission in neutral to prevent the possibility of a self start of a warm engine if the vehicle should roll.
- There is no smoking, lighting matches, any sparks, fires, cigars, pipes within 25 feet.
- Only non-sparking tools are used.
- The interior cargo space is free of protruding bolts, crews or nails.
- The floor of the motor vehicle is tight and lined with either a non-metallic or non-ferrous metal.

RESPONSIBILITIES AFTER LOADING.—The driver shall ensure that:

- The contents are correct and the weights do not exceed state load limits.
- The containers do not leak, are not broken or appear so weak that breakage could occur.
- The cargo is loaded according to the safety officer's or traffic manager's instruction.
- The shipping documents correctly indicate the cargo by type, description, quantity, hazards, class, and placards required.
- The cargo compartment is sealed and the proper placards are displayed.
- The items 23-30 of DD Form 626 are completed and signed. If there are no qualified personnel, the driver may check and sign items 4-30 on this form.

- Upon reaching the destination, the driver will complete items 1, 8, 10, 11, 12, and 17 of a new DD Form 626.

8.9. ROUTES. The driver shall be given the route and maps with special written instructions prior to departure. Drivers shall not divulge the route, movement, or content of the cargo to unauthorized persons. This includes discussions by radio, telephone or personal conversations. The route shall not be changed except in the case of an emergency. Exceptions are as follows:

- On the direct orders of local law enforcement authorities.

- Following accidents or breakdowns which require towing to another locality. Explosives shall be off loaded to another approved vehicle or magazine, prior to towing.

- On the direct order of the Commanding Officer or his designated representatives.

- When dangerous electrical storms are encountered.

- When detours have been established by traffic authorities.

- When safe haven is required during a civil disturbance or natural disaster.

- If cargo is endangered, proceed to the nearest military installation or request protection from local law enforcement office.

8.10. EXPLOSIVES TRANSPORTING PRECAUTIONS. The driver must make every effort to minimize explosives transporting hazards. These precautions include:

- Obeying all road safety rules.
- Keeping engines and chassis clean and oily and grease free.
- Inspecting exhaust system for leaks.
- Keeping a safe distance behind other vehicles.

- Inspecting tires, lights, exhaust system, load, etc., at every highway inspection station or every 2 hours or 100 miles whichever is less.

- Preventing cargo damage by avoiding sharp or fast turns and sharp braking downhill.

- Using extreme caution when driving through snow, ice, sleet, rain, or fog.

8.11. SECURITY. The driver is responsible for the cargo at all times. The driver must stay with the vehicle off station. The doors or covers must be kept tied/locked and sealed. Open trucks must be protected from sun, rain and fire. Classified cargo must be sealed. The driver shall notify either the shipping or receiving activity if seal is broken. If a compromise is suspected, the receiving activities Commanding Officer shall be notified. The driver shall remain with the vehicle until a new seal is applied.

If on station, the vehicle is parked in a barricaded area. The cargo remains sealed; the keys are left in the truck; and, the driver must arrange for security.

8.12. SPECIAL REGULATIONS. There are special driving regulations presented below particularly applicable to the explosives driver.

- Obey speed limit laws, state, local and federal.
- No reckless driving.
- Travel at speed prudent for the type of vehicle, visibility, traffic and road conditions.
- Do not impede traffic by traveling too slow.
- If arrested notify home station and supervisor.
- No hauling explosives at night unless ordered by cognizant authority.
- Maximum of 8 hours driving unless otherwise ordered. The receiving activity may direct driver to travel after approval from driver's assigned command.
- No passengers except: the courier for cargo; a relief driver for trips greater than 8 hours in duration; security guard; or authorized helper.
- Obey all road signs.

- Maintain safe clearance and distance.
- Exercise caution when overtaking, meeting or being passed by other vehicles.
- Use turn signals for passing or turning.
- Exercise caution when:
 - Approaching emergency vehicles.
 - Backing, maneuvering, parking and stopping.
 - Driving near fires ensure it is safe to proceed; do not park within 300 feet of a fire.
- Yield right-of-way to emergency vehicles and military formations.
- Acquire written permission from local authority to pass through a tunnel or bridge. Otherwise, use an alternate route if possible.
- At railroad crossings, come to a stop not less than 15 feet away. Look both directions before proceeding. Do not shift gears while crossing.
- Exempt crossings are street car tracks in business/residential district; abandoned crossings; exempted public utilities crossings; crossings controlled by police or watchman.
- If traveling by convoy, do not become separated by more than 300 feet or closer than 50 feet.
- When crossing a bridge, know condition and load limits. Approach slowly in order to stop safely if necessary. The driver must contact toll authorities prior to reaching a toll or draw bridge. He must advise about the cargo, acquire permission to cross and stop before climbing onto the bridge until signals indicate it is safe to proceed.
- No matches, lighters, fire or other spark producing devices are allowed in/on the vehicle or on the person.
- Keep vehicle clean of oil, grease, rags or other

combustibles.

- Ensure that the driver's view is not obstructed by cargo/other objects and that he is free to move his arms, hands, legs in order to enter or exit from the vehicle.

- Warning signals when stopped shall be approved explosive proof lights permitted within 50 feet of explosives. Emergency reflective triangles are preferred over red flags. The reflectors are placed on each 100 feet in front of and 100 feet in back of this vehicle in the center of the lane it occupies. If the vehicle is stopped within 500 feet of an obstruction, curve, or hill a warning device is placed between 100-500 feet from the vehicle in the direction of the obstruction. The other is placed 100 feet from the vehicle on the opposite end.

- Immediately upon stopping, turn on emergency flashers. Flashers may be turned off after placing the warning signals and must be turned back on when retrieving the warning signals.

8.13. ACCIDENT ACTION PROCEDURES.

Should the motor vehicle be involved in an accident, pull off the road as far as possible and stop the truck immediately. Turn off the ignition, set the handbrake and wheel blocks.

- If a fire is present or suspected, disconnect the battery. If the fire is outside the cargo area, extinguish immediately with on-board fire extinguishers. Post warnings and notify home station and the nearest government installation.

- If the fire is located in the cargo area, extinguish only if fire is not in containers. Otherwise, contact authorities and give special instructions located on DD Form 836. Post warnings and notify home station and the nearest government installation.

- If no fire is present, post warnings and notify authorities. Render first aid if possible. If necessary, gather up scattered cargo and move to a safe area. Advise authorities of cargo hazards and notify home station.

- Do not transfer cargo until a government representative has arrived on the scene.

- Do not sign insurance or release forms.

- Do not express opinions concerning blame for the accident.

- If the vehicle struck is unattended, leave the following for the driver: name, home station, state/federal license numbers, destination, any other pertinent information.

- Do not attempt to disentangle a vehicle until the hazardous cargo is unloaded.

- Acquire names and addresses of those involved and of witnesses.

- Complete the operator's report of motor vehicle accident, SF 91. Section 5-7.2 of NAVSEA OP 2239 explains how to do this.

8.14. BREAKDOWN ACTIONS/PROCEDURES. Breakdown actions and procedures are as follows:

- Move vehicle to a safe location. Do not tow until it is considered safe to do so. Vehicle is not safe to tow until cargo is off loaded.

- Place warning signals.

- Contact authorities.

- Request police guard of 2 men for vehicle.

- Contact home station or destination for help and relief vehicle to transfer cargo.

- Prepare a complete report for home station supervisor and save all bill receipts.

8.15. BURNING AREA OPERATIONS. Explosives drivers engaged in burning area operations shall be under the direction of the ordnance man in charge. The driver is directed by the chief ordnance man to the location for unloading operations or to holding area behind a barricade. The driver shall remain in the vehicle and shall not assist in unloading it. Once unloaded, the driver shall be directed where to park the vehicle with the ignition turned off.

- During an electrical storm, the driver shall park

the vehicle away from personnel shelters or centers. Unless ordered by the Chief Ordnanceman, the driver remains in the vehicle.

- All vehicle floors shall be swept thoroughly at the burn area. Have the Chief Ordnanceman inspect the vehicle before leaving the burning area.

8.16. REPACK AND TRANSFER OF CARGO IN TRANSIT. Any container found damaged or broken during transit may be repacked or repaired when practicable. Use safest methods known to repack containers. Do not repack Class A or B explosives on a public highway, street or road unless it is an emergency.

If repairing package is possible, reinforce it with stout wrapping & twine. Place it in a strong box surrounded by dry fine sawdust or clean cotton waste. Place covers on securely, mark properly, protect and ship to the nearest civil or military authority willing to accept the material. If packages are damaged due to a breakdown or accident, a government representative on the scene shall take charge of the damaged packages.

Prepare a comprehensive report to the home station supervisor containing information on the condition of material, number of containers damaged, recommended preventive action and explosives by type and amount destroyed and by whom if applicable.

8.17. REFUELING A LOADED VEHICLE. Most trips are scheduled so that refueling should not be necessary. However, should refueling be required, the steps listed below should be followed.

- Turn engine and lights off.

- One driver must stand by with a fire extinguisher.

- Ensure no smoking within 50 feet of the vehicle.

- Ground vehicle with wire and alligator clamps or other approved clamps.

- The nozzle of the fuel hose shall be in continuous contact with the intake pipe of the fuel pipe.

- The vehicle shall not be fueled simultaneously

with other vehicles

- A person must be in control of the fueling process at the nozzle of the fuel hose.

8.18. PARKING A VEHICLE WHEN LOADED WITH EXPLOSIVES. Because of the potential danger of parking a vehicle loaded with explosives, special regulations have been established to determine when and where such a vehicle may be parked with the greatest degree of safety to life and property:

- No parking is allowed in a public parking garage, public parking lot. In addition, do not leave the vehicle unattended.

- No parking on public streets (unless permitted by local police), within 300 feet of bridges, tunnels, dwellings, buildings, or where people work, congregate or assemble.

- Do not park within 5 feet of a traveled portion of a street or highway.

On-station parking is authorized by the commanding officer or his designated representative. Parking is then allowed in a designated area. Remote from activity facilities to comply with the Quantity-Distance requirements for the weight of and type of explosives.

The engine must be off, handbrakes set, rear wheels chocked and keys in the ignition unless security precautions recommend against this practice.

8.19. DELIVERY OF LOAD. When the vehicle has reached its destination, the driver shall only deliver the cargo to an authorized person. He must obtain a receipt for this cargo, such as a signed shipping document.

Vehicles must be unloaded as soon as possible. If the driver arrives at the destination after working hours and is unable to have the vehicle unloaded immediately, the local authorities shall direct the driver to an authorized parking area. Should a shipment be refused or cannot be offloaded within 48 hours, the driver shall contact the home station by telephone for instructions.

Drivers waiting at docks for their vehicle to be unloaded shall observe the following instructions:

- Park the vehicle facing an exit in case of an accident.

- Turn off the engine.

- Remain with the vehicle.

- Obey smoking regs—warn others of dangerous cargo.

- Proceed to the unloading area when directed.

Only 3 loaded trucks are permitted at the unloading shed at one time unless authorized by the Naval Sea Systems Command.

CHAPTER 9

EXPLOSIVE STORAGE

9.0. CLASSIFICATION SYSTEM. The Department of Defense uses the UNO classification system for dangerous materials to identify the hazard characteristics of ammunition and explosives. The UNO classification system contains nine hazard classes as indicated in Chart "F". Two of these, Class 1 and Class 6 apply to hazardous materials considered in this manual. Class 1 consists of ammunition and explosives (DOT classes A, B, and C) and blasting agents. Class 6 consists of poisonous substances (Poison B), initiating materials and etiological agents.

CLASS 1 DIVISIONS. Class 1 explosives are further divided into five divisions that indicate the primary characteristic and associated hazards. These divisions are indicated in Chart "G". Classes and Divisions are designated using decimal notation. A Class 1, Division 1 hazard, for example, is designated by 1.1. As a further refinement, a numerical figure in parenthesis is shown to the left of the Class/Division designator to indicate the minimum separation distance, in hundreds of feet, needed for protection from debris, fragments, and firebrands when distance alone is relied on for protection. Separation distances are shown for Class 1, Divisions 1, 2, and 3 hazards; for example, (18)1.1, (08)1.2, or (06)1.3.

9.1. STORAGE BY COMPATIBILITY. All explosives shall be stored by storage compatibility group (SCG) as indicated in NAVSEA OP 5 Vol 2 (Latest Rev.), Chapter 2.

9.2. LOCATION OF MAGAZINES. Outdoor magazines in which high explosives are stored must be located no closer to inhabited buildings, passenger railways, public highways or other magazines, than the

minimum distances specified in NAVSEA OP 5 Vol 1 (Latest Rev.), Chapter 7 .

9.3. CONSTRUCTION OF MAGAZINES. Magazines shall be constructed according to NAVSEA OP-5 Volumes 1-3 (Latest Rev.). All must be bullet, theft, fire and weather resistant. There shall be adequate cross ventilation. The vents are screened to prevent sparks and rodents from entry and must be boxed to prevent magazine contents from blocking these vents.

- There shall be a hazard identification label to indicate potential hazards of contents. See NAVSEA OP 5 Vol 1 (Latest Rev.), Paragraph 4-3.2.1 .

- There should be adequate landscaping to drain water away from the magazine and floor drains if ANFO is stored.

- The magazine temperature must be maintained between 45 degrees to 100 F degrees. Take daily readings during the heat of the day and record. Install high and low temperature recording thermometer. In the winter, heating may be provided by hot water, radiant heat, or forced air. Blowers and coils are located on the outside of the magazine.

- Only approved electric safety flashlights, lanterns or explosive proof lighting systems shall be used.

- Walls and floors must be non-sparking. This may be accomplished by wood lining or lining with non-sparking metals. Nails and screws used to fasten lining are countersunk to prevent contact

Chart F
United Nations Organization Hazard Classes

Class	Type of Hazardous Material
1	Ammunition and Explosives, DOT Classes A, B, and C Blasting Agents.
2	Compresses Gases, Flammable and Nonflammable, Poison gasses (Poison A).
3	Flammable Liquids.
4	Flammable Solids or Substances.
5	Oxidizing Materials.
6*	Poisonous Substances (Poison B), Irritating Materials, Etiological Agents.
7	Radioactive Materials.
8	Corrosive Materials.
9	Miscellaneous Dangerous Substances (Other Regulated Materials).

*Includes ammunition without explosive components but containing toxic chemical agents, and containers of toxic chemical agents in bulk (formerly Q-D Class 8).

Chart G
Hazard Class 1 Division Designators and Types of Hazards

Division Designator	Type of Hazard	Superseded Hazard (Q-D) Classes*
1	Mass Detonating.	7
2	Non-mass Detonating Fragment Producing.	3, 4, 5, and 6
3	Mass Fire.	2
4	Moderate Fire, No Blast	1
5	Very Insensitive.	-

*This column shall not be used to convert superseded Q-D Classes to DOD Class 1 Divisions, or assign a Class 1 Division number to an item not listed in NAVSEA OP 5 Volume 2.

with stored material. Natural or artificial barricades may be used.

ameter case hardened shackles protected by a steel hood.

• Locks must be one of the following:

a. 2 mortise locks.

b. 2 padlocks with separate hasps and staples. Padlocks must have at least 5 tumblers and at least 7/16 inch di-

c. Mortise lock requiring 2 keys to open, or a combination of mortise lock and padlock.

d. 3 point lock or equipment that secures a door to the frame at more than one point.

9.4. MAGAZINE OPERATIONS. The magazine must have a competent person at least 21 years old, in charge. The magazine must be kept locked at all times except when open to place or remove explosives or to conduct an inspection. The magazine should be opened and inspected, at minimum, every 3 days. Explosives should be stored so that the oldest stock can be used first. Other safety regulations such as follows must be adhered to:

- Safety rules for magazine operations are posted on the interior of the door.

- Explosives having the same storage compatibility groups should be stored together, marking showing, and stored in such a manner for easy checking and counting.

- All containers must be closed prior to placing in a magazine.

- Containers should be stacked in a stable manner. Rigid containers are laid flat and cases with the top side up.

- Black powder in the same magazine shall be stacked separately.

- No opening of containers within 50 feet of magazines or other explosives. This includes the unpacking or repacking of damaged explosives.

- No tools shall be stored in magazines. Tools used to open containers must be non-sparking.

- Practice good housekeeping regularly to keep magazine floors free of debris. Sweeping equipment must be non-sparking.

- Destroy deteriorated, unstable, leaking, frozen and water soaked containers.

- Smoking matches, open flames, spark producing devices and firearms are not permitted in the magazine area or within 50 feet of the magazine.

- An area of 50 feet around magazines must be clear to the ground no grass, brush, leaves or rubbish, and all live trees less than 10 feet high.

- Records of explosives received, issued and destroyed must be kept for 5 years and available for inspection by authorities.

9.5. DESTROYING EXPLOSIVES. Explosives shall be destroyed by qualified personnel. If qualified person is not available, contact the Explosive Ordnance Disposal (EOD) office. Destruction of explosives will be done in accordance with NAVSEA OP-5 Vol. 1 (Latest Rev.) Chapter 13.

METHODS.—The best method of disposal is burning. Other methods include dissolving in water or detonation. The latter is used if space and noise levels are not factors.

WHEN TO DESTROY.—Destroy explosives when they are damaged beyond use or deteriorated. Deterioration may be ascertained by excessive hardness or softness, discoloration, excessive leaking, i.e., sawdust is saturated or cases are stained. If the explosives show excessive leaking, contact the EOD office to destroy.

9.6. DISPOSAL. For disposal consult NAVSEA OP 5 Vol 1 (Latest Rev) Chapter 13. Other precautions include:

- Limit disposal to 100 pounds at one time. "Geolbel" AA or similar type is limited to 10 pounds.

- Separate piles at 25 feet to prevent propagation. Never burn explosives in cases or in deep piles, i.e., piles more than 3 inches thick. Treat wrapping and containers as explosives.

- Open containers carefully and ensure no detonators are in the explosives.

- For burning explosives, prepare a mat or layer of paper or wood shavings on the ground several feet longer than the pile. Slit cartridges and spread over the mat. Ignite the mat far enough from explosive to permit taking cover prior to fire reaching explosives. Use new spots for subsequent burning. Burning areas must be approved by NAVSEASYS COM, except when destruction takes place at other than a Naval Facility.

- Nitramon, nitromite and blasting agents may be chopped open and burnt like dynamite. Do not chop

booster. Primers must be covered in sand, earth or water and then detonated.

- Water gels must be detonated in a safe place. For black powder disposal, dig a hole and flush with copious amounts of water. Cover up residues with earth.

- Do not burn det cord on the spool. String out single lines 1/2 inch apart on a mat and burn like dynamite.

- Detonators must be destroyed if caps have been under water, damaged or corroded. Do not throw into lakes, rivers, trenches. These must be destroyed by

detonation and you are limited to 100 or less each time. Place caps in a bag or box in a hole in the ground. Use 1/2 pound prime charge, place over caps in the hole and detonate. This procedure works as well for non-electric caps.

- Do not permit burning of any explosives or detonators in stoves, bon fires, fire places, or confined spaces. Maintain 100 foot safe distance or more in all disposal operations.

- Treat all packing materials as explosives and dispose of them accordingly.

CHAPTER 10

BLASTING AND QUARRY STANDARD OPERATING PROCEDURES

10.0. PURPOSE. To establish a Standard Operating Procedure (SOP) for Blasting and Quarry Operations within the NCF. This SOP is applicable to all personnel assigned to the Naval Construction Forces. It establishes responsibilities and provides guidance in addition to those outlined in NAVSEA OP-5, NAVSEA SW060-AA-MMA-010, and NAVSEA OP-2239. All personnel involved in blasting and quarry operations must be familiar with these procedures. Each quarry site must prepare their own SOP in accordance with these guidelines. NAVFAC Code 123 will provide technical assistance as requested in developing quarry site SOP's.

10.1. SITE APPROVAL.

- Request for CNO site approval/ safety review must be submitted even if local analysis determines that no explosives hazard area will be created.(OPNAVINST 8020.8 Series.)

- Area must be HERO safe.

10.2. EXPLOSIVE LIMITS. The maximum quantity of explosives for a single detonation at the (location) quarry site will not exceed (pounds) net explosive weight (NEW).

10.3. PERSONNEL

- All personnel must be qualified and certified in accordance with OPNAVINST 8023.2 Series. NCTC Instructors must have one year (one deployment) recent blasting experience to qualify as Head instructor of the Blasting and Quarry operations school.

- The minimum number of personnel comprising a "Blasting Team" is four, as follows: one Head Blaster, one Assistant Blaster, and two Crew Members. The minimum number of personnel at the quarry site will be consistent with safe operation.

10.4. RESPONSIBILITIES. The Head Blaster is responsible to ensure compliance with procedures contained in this SOP and reference publications and will act as the Quarry Safety Officer. All personnel present are responsible for compliance with all safety and technical directives applicable to the type of operation being conducted.

10.5. COMMUNICATIONS. Communications available include at least 3 Two way radios (primary, messenger, standby).

10.6. EQUIPMENT.

- First aid kit.
- Dry chemical fire extinguishers (2).
- CO 2 fire extinguishers (2).
- Blasting flags.
- Road signs.
- Warning siren.
- Binoculars.

10.7. SAFETY SUMMARY.

10.7.1. Prior to Conducting Operations. Prior to conducting any operations at the quarry site, the Quarry Safety Officer will:

- Advise the below listed agencies of anticipated operations;
 - a. Fire Department.
 - b. Medical Department.

c. Others as necessary.

- Ensure that all required equipment is operational and located in an area at a calculated safe distance from the blast site and that supplies are available and correctly stored.

- Ensure that fire protection and emergency equipment is immediately available, within 5 minutes.

- Ensure that "caution" signs are appropriately posted in accordance with NAVSEA OP 5 Vol. 1 (Latest Rev.).

- Conduct a task oriented explosive safety briefing.

- Conduct a radio check to enter appropriate net, receive instructions and stand by frequency.

10.7.2. Preparing for Blasting. In preparation for blasting operations, the Head Blaster will ensure that:

- Explosives are transported from the temporary storage magazine to the quarry site in accordance with NAVSEA OP-2239 and as outlined in Appendix AA.

- When explosives arrive at the quarry site, the Officer of The Day (or other appropriately designated official) is notified that the quarry is "HOT". At this time, all road guards are posted at their designated positions by the Head Blaster. All roads into the quarry are blocked so no personnel can enter into the quarry by vehicle or on foot.

10.7.3. Bore Hole Loading Procedures:

- The Head Driller (Assistant Blaster) checks the depth of bore holes and makes log entries of all depths.

- Head Blaster and Assistant Blaster make appropriate changes to blast design if required. The Head Blaster will now approve the load plan to include any changes that may have occurred.

- The Assistant Blaster will ensure all tools and accessories required for the blast setup are brought to the blast site by the crew members.

- Head Blaster obtains, on the blast site, all

explosives required by the approved loading plan.

- Head blaster obtains all blasting caps, initiators and safety use required by the approved loading plan.

- The Assistant Blaster and crew members prime and load all bore holes with required explosives according to the load plan. Head Blaster makes appropriate log entries.

- The Assistant Blaster and Crew members stem all bore holes. Only approved tamping poles will be used. Head Blaster makes appropriate log entries. Tamping Poles will be wood, plastic, or non-ferrous metal, capable of reaching the depth of the hole plus six inches.

- Crew members will police all tools, excess blast materials and trash from the site and proceed to a designated point which is calculated to be a safe distance away from the blast.

10.7.4. Safe Distance. For a Net Explosive Weight (NEW) up to 2000 pounds, the safe distance will be calculated as $1.5 \times \text{NEW}$ or a minimum of 1500 feet, whichever is greater. For a NEW over 2000 pounds NAVSEA OP 5 Vol 1 (Latest Rev.) will apply, i.e., $328 \times \sqrt[3]{\text{NEW}}$.

Example (a) 500 Pounds of Explosives

$$1.5 \times 500 = 750 \text{ Ft.}$$

Use 1,500 Ft. as Safe Distance

(b) 1500 Pounds of Explosives

$$1.5 \times 1500 = 2,250 \text{ Ft.}$$

Use 2,250 Ft. as Safe Distance

(c) 2500 Pounds of Explosives

$$328 \times \sqrt[3]{2500} = 4,451 \text{ Ft.}$$

Use 4,451 Ft. as Safe Distance

10.7.5. Tie-In Procedures:

- The Assistant Blaster will lay down a trunk

line of detonating cord throughout the blast zone to a point where it will be connected to the safety fuse. **AT THIS TIME ALL ROADS WITHIN THE BLAST ZONE ARE SECURED!** From this point tie in will be completed by the Head Blaster and the Assistant Blaster.

- Head Blaster and Assistant Blaster will double check all down line knots and delay connections for correct tying and tightness.

- Head Blaster and Assistant Blaster will proceed to the end of the trunk line at the point where it will be connected to the safety fuse.

10.7.6. Blast Initiation Procedures:

- At this time a section of safety fuse not less than 6 feet is cut and ignited for timing the duration of burn. The test burn must be done a minimum of 100 feet from the point of initiation. The appropriate length of safety fuse needed to accommodate a safe easy retreat to a secure area by the Head Blaster and the Assistant Blaster is then cut. The minimum length of safety fuse allowed for use by the NCF is 6 feet. Prior to attaching the safety fuse and cap to the det cord the road guards and applicable authorities should be notified of the impending blast.

- If utilizing an electric system of initiation, the caps will be fixed to the det cord utilizing the proper cap shunt method to include taping of the connection. Once all caps are connected in a circuit the two leg wires are shunted together, two connecting wires will then be run by the Assistant Blaster to a safe secure area. A test for continuity will be made through the cap circuit and then through the connecting wires to ensure no breaks are present in the circuit. If good continuity exists the connecting wires will be tied into the cap circuit to complete the blast series.

- All roads having been secured, a lookout, using binoculars, performs a visual 360 degree surface sweep and aerial observation of the area for any personnel, vehicles, or aircraft that may be endangered by the blast.

- Five minutes prior to the blast detonation, and prior to lighting the safety fuse or cap initiation, the road guards and control tower must be notified by the Head Blaster. At this time the verbal warning of "FIRE

IN THE HOLE" will be shouted four times, once every 90 degrees in a 360 degree sweep.

- At one minute prior to the blast, the control tower and road guards must be notified. Upon command of the Head Blaster a verbal warning, "FIRE IN THE HOLE" is shouted four times (once every 90 degrees), by the Assistant Blaster.

- Immediately preceding the blast the Head Blaster sounds the warning siren until detonation of the explosive charge. All personnel will remain silent and protected for minimum of 10 seconds in case "Fly Rock" is landing. A waiting period of a minimum of 5 minutes after detonation must be observed prior to approaching the shot to clear it.

- In the event that a misfire occurs (no detonation or partial detonation), follow the mis-fire procedure as outlined in Appendix BB.

- Once detonation has occurred and after a suitable waiting time (at least 5 minutes or until all fumes and dust clears), the shot shall be examined by the Head Blaster and Assistant Blaster, to ensure no hazardous materials remain on the quarry bench and no fires have been started.

- After determining that all is well at the blast site, the Assistant Blaster shall give the notification "ALL CLEAR".

10.8. SAFETY DO'S AND DON'TS—INSTRUCTIONS AND WARNINGS:

- **DO** control explosive materials which have been removed from a magazine to prevent possession by unauthorized persons.

- **DON'T** allow any source of ignition within 50 feet of a blast area (except for lighting safety fuse.) or within 50 feet of a magazine or vehicle containing explosive materials.

- **DON'T** fight fires in explosive materials. Remove all personnel to a safe location immediately and guard the explosive materials against intruders.

- **DON'T** shoot into explosive materials, magazines or vehicles loaded with explosive materials.

- **DON'T** allow unauthorized persons near

explosive materials.

- DON'T use explosive materials that are deteriorated or damaged.

- DON'T insert anything except a safety fuse in a blasting cap.

- DON'T use any explosive materials that have been water soaked even if they appear to be dried out.

- DON'T handle explosives during an electrical storm. All persons should retire to a place of safety.

- DON'T attempt to investigate the contents of a detonator or try to pull the wires, fuse, or detonating cord out of any detonator or delay device.

10.8.1. When Preparing The Primer:

- DO make up primers in accordance with approved methods described in the NCF Blasting and Quarry Operations Manual, and only as needed. Make sure that the detonating cord and booster is completely encased in the explosive and so secured that in loading no tension will be placed on detonating cord at the point of entry into the primer.

- DON'T force a booster into explosive material. Insert the booster in a hole made with a punch suitable for that purpose.

- DON'T use a cast primer or a booster if the hole is too small for the detonator. Never attempt to enlarge the hole.

- DON'T make up primers in a magazine or near other large quantities of explosive materials and DON'T make more than are necessary for immediate needs.

10.8.2. When Drilling and Loading:

- DO carefully examine the surface or face before drilling to determine the possible presence of unfired explosive materials. Never drill into explosive materials or into any hole that has contained explosive materials.

- DO check each bore hole carefully to assure it is in safe condition for loading.

- DO load and unload explosive materials carefully.

- DO transport explosive materials in accordance with Federal, State, and local laws and regulations.

- DO avoid placing any unnecessary part of the body over or in front of the bore hole when loading, tamping and stemming.

- DON'T force explosive materials into a bore

- DON'T slit, drop, deform, tamp or abuse the primer and DON'T drop another cartridge directly on the primer.

- DON'T load a bore hole that contains any hot or burning materials or has a temperature in excess of 150 degrees Fahrenheit (66 degrees Celsius).

- DON'T park vehicles containing explosive materials in areas which are congested or where people congregate.

When Storing Explosive Materials:

- DO locate magazines in the most isolated places available. They should be separated from each other, and from inhabited buildings, highways, and passenger railways by distances no less than those recommended in the NAVSEA OP-5. Vol. 1 (Fifth Rev).

- DO post "EXPLOSIVES—KEEP OUT" signs conspicuously near magazines. These signs should be located so that a bullet passing through them at right angles cannot strike the magazine.

- DO store explosive materials only in a magazine which is clean, dry, well ventilated, reasonably cool, properly located, substantially constructed, weather resistant, and fire resistant.

- DO store only explosive materials and blasting accessories in magazines.

- DO consult your supervisor or the manufacturer if explosive materials have deteriorated

or stained the floor of a magazine.

- **DON'T** store explosive materials in wet or damp places, with flammable or other hazardous materials, or near sources of excessive heat.

- **DON'T** store detonators in the same package with other explosive materials.

- **DON'T** allow combustible material to accumulate within 50 feet of a magazine.

10.8.4. When Using Explosive Materials:

- **DO** close partially used packages of explosive materials.

- **DON'T** carry explosive materials on your person.

- **DON'T** allow metallic slitters to come in contact with any metallic fasteners when opening packages of explosive materials.

- **DON'T** use any explosive materials unless completely familiar with safe procedures for their use, or under the direction of competent, experienced persons.

10.8.5. When Blasting With Detonating Cord:

- **DO** select detonating cord that has characteristics consistent with correct blasting methods and the type of explosive materials being used.

- **DO** handle detonating cord with the same respect given other explosive materials.

- **DO** avoid damaging detonating cord prior to firing.

- **DO** cut the line of detonating cord from the spool before loading the remainder of the charge.

- **DO** make tight connections in accordance with established methods. Cord to cord connections should be made only where the detonating cord is dry.

- **DO** avoid loops, sharp kinks or angles that direct the cord back toward the incoming line of detonation.

- **DO** connect detonators to the detonating cord by methods recommended by the manufacturer or COMNAVSEASYS COM whichever is more stringent. The detonators should always be pointed toward the desired direction of detonation.

- **DON'T** attach detonators to detonating cord until ready to initiate the blast.

10.8.6. When Blasting With Non-Electric Blasting Caps:

- **DO** follow manufacturers instructions and warnings. Emphasize proper hookup procedures and safety precautions, as per NAVSEA OP-5 Vol. 1 (Latest Rev.).

- **DO** discontinue operations during electrical storms.

- **DON'T** use the detonating cord lines for any purpose other than that intended by the manufacturer.

- **DON'T** drill, bore or pick out a charge of explosive materials that has misfired. Misfires should be handled only by or under the direction of a competent and experienced person, and then only in compliance with Appendix BB and the NAVSEA OP-5 Vol. 1 (Latest Rev.).

10.8.7. Explosive Materials Disposal:

- **DO** dispose of or destroy explosive materials in accordance with the manufacturers instructions and the NAVSEA OP-5, Vol. 1 (Fifth Rev).

- **DON'T** leave explosive materials or their packages where unauthorized persons can access them.

10.9. RECOMMENDATIONS FOR MINIMIZING HAZARDOUS GAS PRODUCTS FROM USE OF EXPLOSIVE MATERIALS:

- **DO** use the largest diameter cartridge that is compatible with the job.

- **DO** avoid all conditions that may cause the explosive material to burn rather than detonate.

- **DO** always use water-resistant explosive materials in wet work and fire the blast as soon as

practicable after loading.

- DO** use noncombustible materials where stemming is required.

- DON'T** use explosive materials that are deteriorated or damaged.

- DON'T** load more explosive material than is necessary to do the job properly.

- DON'T** add combustible materials to the charge

10.9. HANDLING AND USE:

- DO** avoid exposure to excessive noise from blasting in accordance with applicable Federal, State, or local laws and regulations.

- DON'T** allow ingestion, food contamination, prolonged skin exposure, contact with eyes, or prolonged inhalation of dust or vapors from explosive

materials. **DO** flush areas of contact with large quantities of water.

- DON'T** abuse packaging of explosive materials.

- DON'T** attempt to produce "homemade" explosive materials or alter the composition of explosive materials.

- DON'T** remove explosive material from the package unless it is designed for use in that manner.

- DON'T** strike or attempt to take apart detonators, primers or boosters.

- DON'T** stack more explosive materials than are needed near working areas during loading.

- DON'T** tamp the primer. **DON'T** tamp explosive materials with metallic devices except for wooden jointed poles with non-ferrous metal connectors. Avoid violent tamping.

**LIST OF APPENDICES FOR STANDARD
OPERATING PROCEDURES (TO BE
INCLUDED IN THE PREPARATION OF
QUARRY SITE STANDARD OPERATING
PROCEDURES .**

AA. Transportation of Explosives

BB. Misfire Procedures

CC. Storage of Explosives

DD. Securing the Quarry

EE. Mishap Procedures

FF. Safe Distances

GG. Hazardous Material Handling Brief

APPENDIX B

NAVFAC 8000/2 (2/91)

Blasting and Quarrying Loading Record

Head Blaster: _____ Date: _____ Safe Firing Distances: _____

Quarry Location: _____ Firing Time: _____ Hours

Hole No.	Main Charge	Primer Used	Stemming Type/Amt	Depth	Hole Dia.	Burden & Spacing	Hole Delay	Adjustment (if any)
1.			/ ft		in	ft/ ft	MS	
2.			/ ft		in	ft/ ft	MS	
3.			/ ft		in	ft/ ft	MS	
4.			/ ft		in	ft/ ft	MS	
5.			/ ft		in	ft/ ft	MS	
6.			/ ft		in	ft/ ft	MS	
7.			/ ft		in	ft/ ft	MS	
8.			/ ft		in	ft/ ft	MS	
9.			/ ft		in	ft/ ft	MS	
10.			/ ft		in	ft/ ft	MS	
11.			/ ft		in	ft/ ft	MS	
12.			/ ft		in	ft/ ft	MS	
13.			/ ft		in	ft/ ft	MS	
14.			/ ft		in	ft/ ft	MS	
15.			/ ft		in	ft/ ft	MS	
16.			/ ft		in	ft/ ft	MS	
17.			/ ft		in	ft/ ft	MS	
18.			/ ft		in	ft/ ft	MS	
19.			/ ft		in	ft/ ft	MS	
20.			/ ft		in	ft/ ft	MS	
21.			/ ft		in	ft/ ft	MS	
22.			/ ft		in	ft/ ft	MS	

Blasting & Quarrying Shot Record and Blasting Inventory

Date Explosives Drawn: _____ Date Explosives Expended: _____

Date Explosives Returned: _____

EXPLOSIVE LISTING	LOT NO.	AMT. DRAWN	AMT. EXPENDED	AMT. RETURNED
ANFO-P	_____	_____	_____	_____
BLASTRITE	_____	_____	_____	_____
DET-CORD (25/50)	_____	_____	_____	_____
DETA PRIMES	_____	_____	_____	_____
MS-15 EBC 5	_____	_____	_____	_____
MS-50 EBC 5	_____	_____	_____	_____
MS-75 EBC 5	_____	_____	_____	_____
MS-100 EBC 5	_____	_____	_____	_____
NON-ELECTRIC CAPS	_____	_____	_____	_____
SAFETY FUSE	_____	_____	_____	_____
FUSE LIGHTERS	_____	_____	_____	_____
MS CONNECTORS	_____	_____	_____	_____
MISC. EXPLOSIVES	_____	_____	_____	_____
_____	_____	_____	_____	_____
_____	_____	_____	_____	_____
_____	_____	_____	_____	_____

TOTAL EXPLOSIVES: _____

GENERAL INFORMATION

Type of shot (elec./non-elec.) If electric OHMS resistance _____

Blasting machine used (Primary) _____ (Secondary) _____

Type of quarry (i.e. open pit, bench) _____

Location of shot in quarry (i.e. bench) _____

Total number of holes loaded _____

Total number of holes abandoned _____ Reason _____

Type of holes (Circle one: inclined/vertical/horizontal) _____

Type of material blasted _____

Estimated cubic yards of rock to be produced _____

Estimated size of rock _____ Actual avg. size rock _____

Number of misfires (if any) and cause if known _____

Action taken on misfire _____

Drilling problems (if any) _____

Loading problems (if any) _____

Recommendations for drilling or loading problems _____

Submitted: _____ Date: _____

Approved: _____ Date: _____

APPENDIX AA

TRANSPORTATION OF EXPLOSIVES

1. REQUIRED FORMS AND DOCUMENTATION FOR TRANSPORTATION OF EXPLOSIVES.

- DD Form 626, Motor Vehicle Inspection (Transportation Hazardous Material).

- DD Form 836, Special Instructions For Motor Vehicle Drivers

- NAVSEA OP 2239, (Technical Manual, Motor Vehicle Driver's Handbook, Ammunition, Explosives, and Hazardous Materials) must be present in the vehicle.

- Valid DD Form 1970 trip ticket

- Driver must possess valid SF 46 (qualified to haul explosives).

- Driver must possess valid Medical Examiner's Certificate (DL51A)

- Driver must possess a valid state driver's license if he is driving in the U.S.

2. PROCEDURES.

Procedures will be developed in accordance with local governing directives.

APPENDIX BB

MISFIRE PROCEDURES

1. MISFIRES NAVSEA SW-060-AA-MMA-010.

NONELECTRIC MISFIRES.—The following procedures must be followed in the event of misfires of charges primed with nonelectric blasting caps and safety fuse:

- Notify road guards immediately.
- Allow a minimum of 30 minutes to elapse, after the maximum delay predicted for any part of the demolition shot has passed, before starting to investigate.
- Insert a new fused blasting cap into the charge only if this can be done without disturbing the old blasting cap, otherwise prime and place a new charge close enough to the original charge to insure detonation of both. Do not disturb the original charge, its blasting cap, or fuse.
- Ignite the new fuse or fuses.

WARNING:

USE TWO MEN, ONE AS A BACKUP AT A SAFE DISTANCE, WHEN APPROACHING A MISFIRE.

WARNING:

DO NOT HANDLE OR DISTURB A MIS-FIRED BLASTING CAP.

WARNING:

DO NOT STRIKE OR DIG INTO A BURIED MISFIRED CHARGE.

ELECTRIC MISFIRES.—Because of the hazards of burning charges and delayed explosions, electric misfires must be cleared with extreme caution. In the event of a misfire, make three successive

attempts to fire. If unsuccessful remove the firing wires from the blasting machine and check continuity of the firing circuit, if continuity is good connect the firing wires to the blasting machine and make three more successive attempts to fire. Check the connections of the firing wires to the terminals of the blasting machine and make three more successive attempts to fire. If still unsuccessful, disconnect the firing wire ends from the blasting machine and shunt by twisting the firing wire ends together. Prior to commencing an investigation of an Electric Misfire a 30 minute waiting period must be observed.

If one or more of the charges is primed for both electric and nonelectric initiation and cannot be fired electrically wait until the nonelectric system has fired. If the nonelectric circuit has not fired the charge after its maximum predicted delay has elapsed, wait an additional 30 minutes before conducting an investigation. If delay firing devices (DFD) are utilized in conjunction with electrically initiated charges, follow the waiting time prescribed in the (DFD) manuals, or 30 minutes, which ever is greater.

WARNING:

THE BURYING OF ELECTRIC BLASTING CAPS IS NO LONGER AUTHORIZED WITHIN THE NCF.

WARNING:

USE TWO MEN, ONE AS A BACKUP AT A SAFE DISTANCE WHEN APPROACHING A MISFIRE.

WARNING:

DO NOT HANDLE OR DISTURB A MIS-FIRED BLASTING CAP.

- Disconnect the old blasting cap wires and short them. Do not disturb the blasting cap.
- Test the firing circuit with the circuit tester for breaks and short circuits and correct any defects discovered.
- Connect the wires of the new blasting cap(s) to the firing circuit and reprime the charge only if this can be done without disturbing the old blasting cap, otherwise prime and place a new charge to insure the detonation of both.
- Reconnect the firing wire ends to the blasting machine and fire the charge or charges.
- If the charges were primed with both electric and nonelectric firing systems, execute the appropriate procedure for both systems.

COMBINATION NONELECTRIC AND ELECTRIC MISFIRES—If the nonelectric circuit has not fired the charge after its maximum predicted delay has elapsed, wait an additional 30 minutes before proceeding. If the charges were primed with a combination of priming systems, execute the appropriate procedure for both systems after waiting the appropriate required time period.

MISFIRES WITH DETONATING CORD SYSTEMS.—Misfire procedures are given for the following types of detonating cord system misfires:

● **Nonelectric Cap Fails to Fire.**

If a nonelectric cap fails to fire, remain at a safe distance until at least 30 minutes after the time at which the charge should have detonated; a hangfire may be in progress. After the waiting period has elapsed, cut the detonating cord main line between the cap and the charge, and fasten a new cap to the detonating cord.

● **Electric Cap Fails to Fire.**

If an electric cap fails to fire, delay investigation a minimum of 30 minutes. Search

for breaks and short circuits in the electric firing system. Cut the detonating cord main line between the cap and the charge, and fasten the new cap to the detonating cord.

● **Cap Fires, but Cord Fails.**

If an electric or nonelectric cap is used to fire the detonating cord and the cap explodes but fails to detonate the cord, delay investigation a minimum of 30 minutes. Fasten a new cap to the detonating cord, taking special care to fasten it properly.

● **Main Line Detonates, but Branch Line Fails.**

If the detonating cord main line detonates but a branch line fails to detonate, fasten a cap to the branch line and fire it separately.

● **Cord Fires but Charge Fails.**

If the detonating cord leading to a charge detonates but the charge fails to explode delay investigation a minimum of 30 minutes. If the charge still is intact, reprime. If the charge is scattered by detonation of the original detonating cord, reassemble the explosive or, using as much of the original explosive as practicable, place a new charge and insert a new primer. Every attempt must be made, particularly in training exercises, to recover all explosives scattered by a misfire. If the charge is buried carefully, remove the earth cover, reprime the charge if intact, or place a new charge along side of the failed charge. When multiple charges are connected by branch lines/trunk lines, a 30 minute delay must be observed before investigating.

● **Firing Device Fires but Detonator Fails.**

If a firing device fires but the detonator does not, place another detonator on the cord and

fire again. Do not touch the firing device or original detonator with any part of the body or any object; the detonator may detonate from a slight jar. Detonation of the cord should produce the detonation of the original detonator.

• **Detonator Fires, but Cord Fails.**

If the detonator fires but the cord does not, wait a minimum of 30 minutes before investigating. Place a new detonator on the cord, making sure that the detonator is properly connected, and fire again.

WARNING:

USE TWO MEN, ONE AS A BACKUP AT A SAFE DISTANCE WHEN APPROACHING A MISFIRE.

WARNING:

DO NOT HANDLE OR DISTURB A MISFIRE BLASTING CAP.

WARNING:

DO NOT STRIKE OR DIG INTO A BURIED MISFIRE CHARGE.

2. BURIED ELECTRIC BLASTING CAPS.
(THE BURYING OF ELECTRIC BLASTING CAPS REQUIRES PRIOR APPROVAL FROM NAVFAC-ENGCOR (CODE 123). THE FOLLOWING DESCRIPTION IS FOR INFORMATION ONLY.)

If stemming must be removed in order to top prime a column of explosives containing an electric blasting cap, great care must be used. The best method is to remove the stemming with a water hose. The hose should be equipped with a valve to regulate the flow of water. No metal of any type should be put into the hole. Never pull on the wires of electric blasting caps. Vigorous pulling on the wires from a live cap could cause a detonation.

When all the stemming has been removed insert a new prime charge and fire. Do not return to the blast area for at least one hour. While removing the stemming, the original explosive charge may have been saturated with water to the extent that it will not detonate even from the impact of the new prime charge. However, the new prime charge may generate sufficient heat to start the original misfire charge to burning. This will result in a dangerous "hang-fire." The sound of the reprimed charge firing is not a dependable indication that it is safe to return to the blast area.

APPENDIX CC

STORAGE OF EXPLOSIVES

1. SAFE STORAGE OF AMMUNITION AND EXPLOSIVES. The safe storage of ammunition and explosives at Navy and Marine Corps shore activities, regardless of ammunition and explosives ownership, is under the cognizance of NAVSEASYSKOM. Storage shall conform to the regulations stated in NAVSEA OP 5 VOLUME 1 (Latest Rev.), as well as to the safety standards promulgated by the Department of the Navy, and applicable federal, state, and local regulations that are not in conflict with those of NAVSEASYSKOM. Conflicts in regulations shall be brought to the attention of NAVSEASYSKOM (SEA-665) for resolution.

2. DO'S AND DONT'S:

STORAGE.—

- **DO** provide adequate magazine ventilation.
- **DO** provide adequate magazine ventilation in accordance with the NAVSEA-OP

2239 and all applicable federal, state and local laws.

- **DON'T** manufacturer's recommendations for explosive storage time and temperature.
- **DO** clean up spills promptly in accordance with manufactures recommendations.

AFTER BLAST.—

- **DO** assume toxic fumes are present from all blasts or burning explosive materials.
- **DO** comply with applicable federal, state and local laws and regulations for safe fume levels before returning to the blast area.

APPENDIX DD

SECURING THE QUARRY

1. PRIOR TO SECURING THE QUARRY:

- Ensure that the immediate area is policed and undetonated explosives are disposed of in accordance with NAVSEA OP- 5, Vol 1, (Latest Rev.) chapter 13.
- Ensure machinery and supplies are stowed correctly and securely.
- Advise road guards and all necessary personnel that quarry is cleared of all personnel, "All Cold."

APPENDIX EE

MISHAP PROCEDURES

1. MISHAP PREVENTION. Training for mishap prevention shall be adhered to by all hands (CNETINST 1500.20B Series).

- Competent personnel render necessary first aid.
- Immediately summon Medical and Fire Department.
- Notify immediate supervisor.

1.1. Each Space Will Have the Following Posted in a Conspicuous Place:

- Emergency phone number list with location of emergency services.
- Evacuation routes.
- Primary power disconnect switch location.

1.2. All Personnel are Required to Wear Personal Protective Equipment While Operating Construction Equipment:

PERSONAL SAFETY EQUIPMENT REQUIRED ON THE JOB.—

- Hard hat.
- Safety shoes.
- Hearing protection.

OPTIONAL ITEMS (UNDER NECESSARY CONDITIONS).—

- Safety goggles.
- Respirators.
- Reflective clothing.

- Durable gloves (Rubber gloves for refueling).

2.0. REPORTING UNSAFE CONDITIONS. It is an all hands responsibility to report unsafe working conditions. OPNAV-5100/2 will be submitted to the Divisional Safety Representative for action.

3.0. EMERGENCY PHONE NUMBERS. These numbers are also posted in each space. Know the location and ensure all personnel are aware of the locations of the numbers and the nearest telephone:

EMERGENCY	PHONE NO.	LOCATION
Medical/Ambulance	(----)	(Location)
Fire Department	(----)	(Location)
Base Security	(----)	(Location)
Officer of the Day	(----)	(Location)

NOTE:

ALL SERIOUS INCIDENTS WILL BE ENTERED IN THE COMMAND OFFICIAL LOG.

NOTE:

ALL SUPERVISORY PERSONNEL WILL BE TRAINED IN CPR AND BASIC FIRST AID.

NOTE:

IN THE EVENT OF ELECTRICAL SHOCK, REMOVE THE VICTIM FROM THE SOURCE BY SECURING ELECTRICAL POWER, OR USE A NONCONDUCTIVE ITEM SUCH AS A WOOD STICK TO KNOCK THE LIVE CONDUCTOR AWAY. (ALL HANDS RESPONSIBILITY.)

APPENDIX FF

SAFE DISTANCE

1. **SAFETY.** All personnel involved in blasting operations should become familiar with NAVSEA SW060-AA-MMA-010, CHAPTER 8, *SAFETY REQUIREMENTS AND PRECAUTIONS*.

- Don't expose personnel to fragments or debris.
- Use barricades between personnel and blast site
- Calculate safe distance as pertaining to amount of explosive used.

2. **SAFE DISTANCE.** For a Net Explosive Weight (NEW) up to 2000 pounds, the safe distance will be calculated as 1.5 x the NEW or a minimum of 1500 feet, whichever is greater. For a

NEW over 2000 pounds NAVSEA OP 5 Vol 1 (Latest Rev.) will apply, i.e., $328 x \sqrt[3]{NEW}$.

Example (a) 500 Pounds of Explosives

$$1.5 x 500 = 750 \text{ Ft.}$$

Use 1,500 Ft. as Safe Distance

(b) 1500 Pounds of Explosives

$$1.5 x 1500 = 2,250 \text{ Ft.}$$

Use 2,250 Ft. as Safe Distance

(c) 2500 Pounds of Explosives

$$328 x \sqrt[3]{2500} = 4,451 \text{ Ft.}$$

Use 4,451 Ft. as Safe Distance

APPENDIX GG

HAZARDOUS MATERIAL HANDLING BRIEF

1. GENERAL DESCRIPTION OF EXPLOSIVES.

ANFO (AMMONIUM NITRATE-FUEL OIL).—ANFO is a blasting agent consisting of fuel oil and an oxidizer. The most used ANFO is an oxygen balanced, free flowing mixture of 94% ammonium nitrate prills and 6% No.2 Diesel fuel. It has a density between .80-.85 g/cc and a velocity between 7,000-15,600 ft/sec. ANFO is packaged in 50 pound bags or delivered in bulk.

WATER GEL EXPLOSIVES.—Water Gel explosives are usually referred to by their manufacturer name (i.e., TOVEX, BLASTRITE, etc.). Water Gel explosives consist of oxidizing salts, fuels sensitizers dissolved in a continuous state. They are cap sensitive to a #6 blasting cap. Water Gel explosives are a medium density explosive, about 1.18 g/cc, with a velocity of 15,000 ft/sec. They are shipped in bulk or packaged in a light weight film plastic. They come in a 50 pound box.

M-1 MILITARY DYNAMITE.—Military Dynamite is an RDX based explosive containing no nitroglycerin. It is a medium velocity explosive detonating at 22,600 ft/sec. The explosives are enclosed in a paraffin coated cylindrical cartridge about 1.25" in diameter and 8" long, weighing approximately .5 lbs. Military dynamite is detonated by a blasting cap or detonating cord.

DETONATING CORD (50 GR AND 25 GR)
Detonating cord is a "rope like" explosive consisting of an outer layer of fabric (textile rubber and plastic) and an inner core of high explosive, either PETN or RDX. It detonates at a velocity between 20,000 -23,000 ft/sec. Detonating cord is #6 cap sensitive and packaged in 1,000 ft. spools.

NONEL.—Nonel is a small diameter plastic laminate shock tube coated with a very thin layer of reactive material. It burns at approximately 6500 feet per second. A nonelectric detonation cord initiator is used to initiate the shock tube. This shock wave will propagate through most sharp bends, knots and kinks in the tube. The detonation is sustained by such a small quantity of reactive material, the outer surface of the tube remains intact during and after functioning. NONEL shock tube cannot be initiated by high frequency radio transmissions, static or stray electrical energy, flame, friction or impact during normal use. NONEL requires no knowledge of electric circuitry

NON-ELECTRICAL BLASTING CAPS (NEC'S).—NEC'S are small devices designed to initiate or detonate other charges of explosives. They have an aluminum shell, typically about .25" in diameter and 1" to 3" long. NEC'S have an open end for insertion of safety fuse which provides a spit of flame to detonate them. NEC'S contain either PETN or RDX as an explosive.

SAFETY AND TIME FUSE.—Safety Fuse is the medium through which a flame is conveyed at a relatively uniform rate of ignition of blasting caps. The fuse consists of an ammonium nitrate black powder core encased in a fiber wrapping that is waterproofed. Safety fuse burns at a rate of about 40 ft./sec. Igniting the safety fuse is accomplished by matches, M-60 fuse lighter or other approved methods.

BIBLIOGRAPHY

<u>PUBLICATION NUMBER</u>	<u>TITLE</u>
NCTC 8020.1	BLASTING GUIDANCE MANUAL BLASTING TECHNIQUE ENGINEERING GEOLOGY EXPLOSIVES AND ROCK BLASTING JOURNAL OF EXPLOSIVES- ENGINEERING MONTHLY ROCK DRILLING TIPS REGULATIONS AND RESPONSIBILITIES FOR HANDLING, TRANSPORTING, AND STORING EXPLOSIVES
NAVSEA OPS NCTC 8023.1	NAVAL EXPLOSIVES SAFETY REQUIREMENTS AND RESPONSIBILITIES FOR BLASTERS QUALIFICATIONS AND ISSUANCE OF NEC 5708
NCTC 8023.2	BLASTING AND QUARRY STANDARD OPERATING PROCEDURES
PT 1900-1910 PT 1926 TM 5322 TM 5-545 TM 5331C	29 CODE OF FEDERAL REGULATIONS 29 CODE OF FEDERAL REGULATIONS PITS AND QUARRIES GEOLOGY ROCK CRUSHERS, AIR COMPRESSORS AND HAND TOOLS VOL. 3
TM 9-1300-214 TM 5-25 OP 2239	MILITARY EXPLOSIVES EXPLOSIVES AND DEMOLITION NAVSEA MOTOR VEHICLE DRIVER'S HANDBOOK, AMMUNITION, EXPLOSIVES AND RELATED HAZARDOUS MATERIAL BLASTERS HANDBOOK
PUB #2 PUB #3	THE AMERICAN TABLE OF DISTANCE SUGGESTED CODES OF REGULATIONS FOR THE MANUFACTURE, TRANSPORTATION, STORAGE, SALE, AND USE OF EXPLOSIVE MATERIAL
PUB #4	DO'S AND DON'TS INSTRUCTIONS AND WARNINGS
PUB #11 PUB #17	AGRICULTURAL BLASTING SAFETY IN THE TRANSPORTATION, STORAGE, HANDLING AND USE OF EXPLOSIVES
PUB #20	SAFETY GUIDE FOR THE PREVENTION OF RADIO FREQUENCY RADIATION HAZARDS IN THE USE OF ELECTRIC BLASTING CAPS
PUB #21	HOW TO DESTROY EXPLOSIVES HANDBOOK OF ELECTRIC BLASTING CAPS FEDERAL MOTOR CARRIERS SAFETY REGULATIONS

FM 3-34.468
19 DECEMBER 2003

By Order of the Secretary of the Army:

PETER J. SCHOOMAKER
General, United States Army
Chief of Staff

Official:

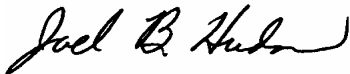

JOEL B. HUDSON
*Administrative Assistant to the
Secretary of the Army*
0401217

DISTRIBUTION:

Active Army, Army National Guard, and US Army Reserve: To be distributed in accordance with initial distribution number **115914**, requirements for FM 3-34.468.

PIN: 081209-000